

# TOKICO

## Positive Displacement Oil Flowmeters (Mechanical Indicator Type)

### Overview

TOKICO has a long history of producing high quality flow meters since 1950 in the fuel measurement field. Our flowmeters are used in a wide variety of applications including measuring of boiler fuel oil and diesel oil, as well as for transactions for kerosene, light oil and heavy oil. We have been serving numerous customers with accurate, compact, and excellent durability flowmeters.

### Features

- High accuracy  
Accuracy is within  $\pm 0.5\%$   
Fluid is directly measured by gear or roots, enabling accurate measuring.
- Compact design  
The flowmeter is compactly designed, yet the indicator is easy to read.
- Excellent durability  
Simple structure enables long term durability with virtually no degradation of accuracy.



#### FGB Type

Size : 15mm (1/2B) ~ 25mm (1B)

- Suitable for small volume flow between 40 ~ 3000L/h
- Employs gear-type rotors made of resin



#### FRO Type

Size : 40mm (1 1/2B) ~ 50mm (2B)

- Suitable for medium volume flow between 0.8 ~ 15 m<sup>3</sup>/h (800 ~ 15,000L/h)
- Employs roots rotors made of aluminum alloy
- Roots rotors rotate without physical contact  
⇒ Extremely low pressure loss  
⇒ Accuracy remains unchanged over a long period of time



#### FRP Type

Size : 80mm (3B) ~ 100mm (4B)

- Suitable for large volume flow between 0.6 ~ 130m<sup>3</sup>/h
- Employs roots rotors made of cast iron
- Roots rotors rotate without physical contact  
⇒ Extremely low pressure loss  
⇒ Accuracy remains unchanged over a long period of time

# Standard Specifications

		FGB type	FRO Type	FRP type
Accuracy		±0.5%		
Flow range		Refer to next page		
Max. working pressure		1MPa		
Hydraulic test pressure		2MPa		
Max. working temperature		Size 1/2B --Kerosene, diesel/light oil, A heavy oil : 80°C Size 3/4B & 1B : --Kerosene, diesel/light oil, : 80°C --A,B,C heavy oil : 120°C	Kerosene, diesel/light oil : 50°C A, B, C heavy oil : 100°C	Kerosene, diesel/light oil : 50°C A,B,C heavy oil : 100°C with fin : 150°C
Flange rating		JIS10K FF		
Material	Body	Size 1/2B : FC250 (Cast iron) Size 3/4B & 1B : FCD400 (Ductile iron)	FC 250 (Cast iron)	FC 250 (Cast iron)
	Rotor	Size 1/2B : Phenol resin Size 3/4B & 1B : PPS resin	ADC12 (Alluminum alloy die cast)	FC (Cast iron)
Counter unit		04X : Totalizing counter (7 digits), Reset counter (5 digits) 02X : Totalizing counter (7 digits)		04X2 : Totalizing counter (7 digits) Reset counter (5 digits) 02X2 : Totalizing counter (7 digits)
Electrical transmitter unit	Transmitter	Reed switch (02S, 04S)	Microswitch (02M, 04M)	<ul style="list-style-type: none"> <li>• Non-contact type (F)</li> <li>• Reed switch type (S) (R)</li> <li>• Microswitch type (M)</li> </ul>
	Output pulse	Max. 10Hz	Max. 5Hz	
	Contact life time	10 million times	5 million times	
	Cable	Double core shield cable	Double core shield cable	
Flow direction		Right → Left (Standard)		
Painting color		Munsell 1.4PB 3.1/1.2		

## Pressure Loss Characteristics

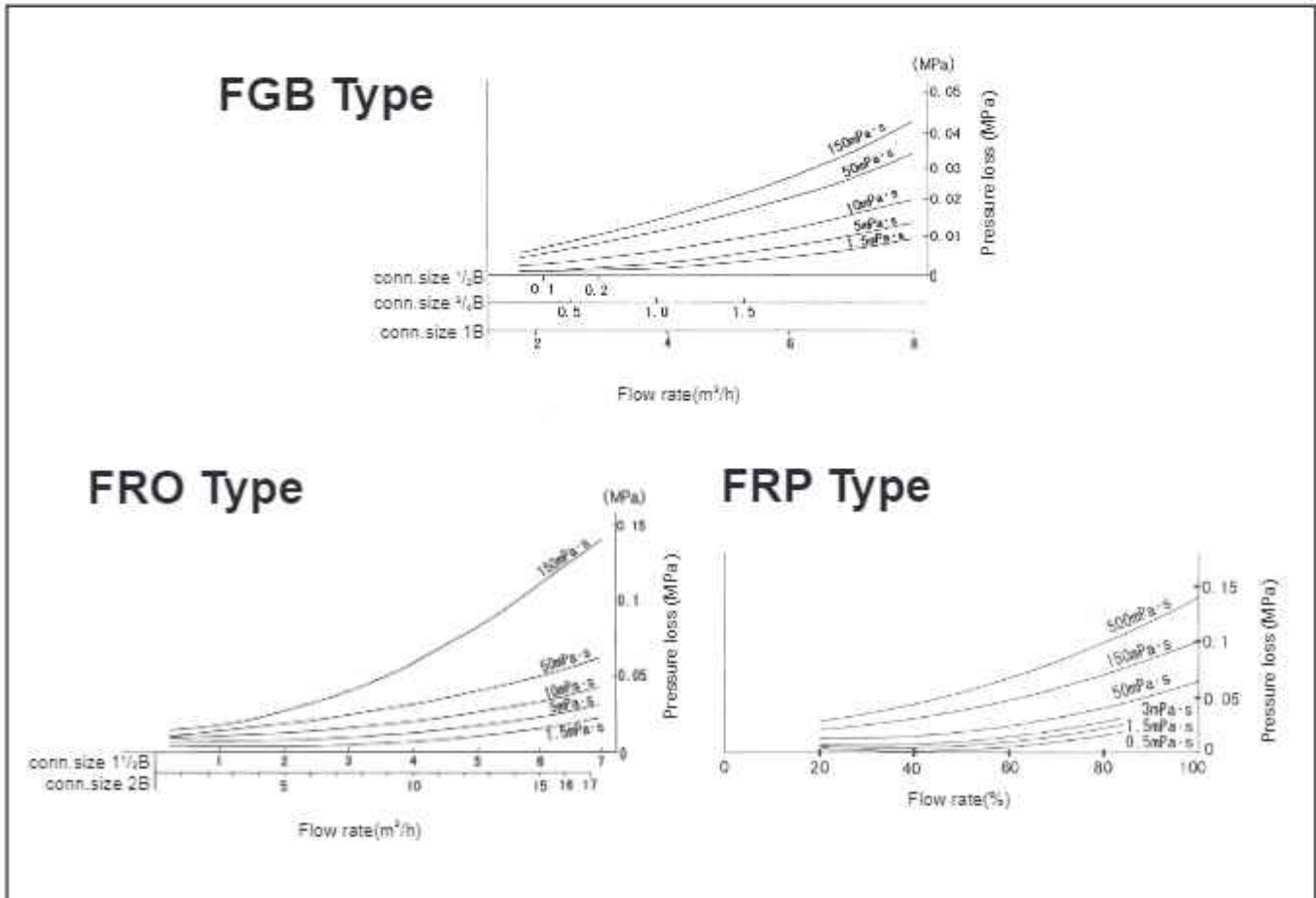

## Flow range

Model	Condition	Flow range (L/h)			
		Kerosene (1.5mPa·s)	Diesel, Light oil (5mPa·s)	A Heavy oil (10mPa·s ~)	B,C Heavy oil (50 ~ 300mPa·s)
FGBB423BAL	Standard	70 ~ 200	40 ~ 200	20 ~ 200	—
FGBB631BDL	Standard	150 ~ 1250	120 ~ 1250	40 ~ 1250	20 ~ 1250
FGBB835BDL	Standard	150 ~ 3000	150 ~ 3000	100 ~ 3000	40 ~ 3000

Model	Condition	Flow range (m <sup>3</sup> /h)	
		Kerosene, Light oil (0.9 ~ 5mPa·s)	Heavy oil (5 ~ 300mPa·s)
FRO0438	Intermittent	0.8 ~ 7.0	0.1 ~ 7.0
	Continuous	0.8 ~ 4.5	0.1 ~ 6.0
FRO0541	Intermittent	1.5 ~ 15.0	0.25 ~ 15.0
	Continuous	1.5 ~ 9.0	0.25 ~ 13.0

Model	Condition	Flow range (m <sup>3</sup> /h)			
		Kerosene (0.9 ~ 2mPa·s)	Light oil (2 ~ 5mPa·s)	A,B Heavy oil (5 ~ 150mPa·s)	C Heavy oil (150 ~ 500mPa·s)
FRP0845BAA	Intermittent	5 ~ 35	3.5 ~ 40	0.6 ~ 40	0.6 ~ 35
	Continuous	5 ~ 25	3.5 ~ 35	0.6 ~ 35	0.6 ~ 25
FRP1051BAA	Intermittent	16 ~ 120	12 ~ 130	4 ~ 130	4 ~ 120
	Continuous	16 ~ 85	12 ~ 120	4 ~ 120	4 ~ 85

## Dimensions









FGBB631BDL FGBB835BDL (-02X, -04X)		FRP0845BAA FRP1051BAA (-02X2-X) (-04X2-X)	
FRO0438 FRO0541 (-02X, -04X)			

Model	Model number	Size		Dimensions (mm)				Approx. weight (kg)
		mm	inch	φD	L	A1	A2	
FGB Type	FGBB423BAL - 02X, 04X	15	1/2	95	130	---	181	6
	FGBB631BDL - 02X, 04X	20	3/4	100	170		122	7
	FGBB835BDL - 02X, 04X	25	1	125	200		133	10
FRO Type	FRO0438 - 02X, 04X	40	1 1/2	140	200	77	177	17
	FRO0541 - 02X, 04X	50	2	155	250	99	190	20
FRP Type	FRP0845BAA - 02X2-X, 04X2-X	80	3	185	300	89	170	45
	FRP1051BAA - 02X2-X, 04X2-X	100	4	210	450	180	275	100

## Specifications

Model	Conn. size		Model Number				Pointer (/rev)	Indicator				Transmitter	
			Base code	Standard (with zero reset)	Totalizer only	With pulse transmitter		Totalizer		Reset Counter		Type	Transmission unit (L/P)
	(mm)	(inch)						digits	unit	digits	unit		
FGB Type	15	1/2	FGBB423BAL- □□□	-04X	-02X	-02S -04S	1L	1L	1L	1L	Reed switch (S)	0.1(std.) or 1	
	20	3/4	FGBB631BDL- □□□										
	25	1	FGBB835BDL- □□□										
FRO Type	40	1 1/2	FRO0438- □□□	-04X	-02X	-02M -04M	10L	7	10L	5	10L	Micro-switch (M)	1(std.) or 10
	50	2	FRO0541- □□□										
FRP Type	80	3	FRP0845BAA- □□□□ - X	-04X2-X	-02X2-X	-□□F□-X -□□R□-X -□□S□-X -□□M□-X	100L	100L	100L	100L	4 types (FRSM)	0.1(F) 10 (R,S,M)	
	100	4	FRP1051BAA □□□□ - X										

## Indicator

Model	Conn. size		Model Number		
	(mm)	(inch)	Standard (with zero reset)	Totalizer only	With pulse transmitter
FGB	15	1/2	04X 	02X 	02S 
	20	3/4			
	25	1			
FRO	40	1 1/2	04X 	02X 	02M 
	50	2			
FRP	80	3	04X2-X 	02X2-X 	02F2 
	100	4			

## Strainer

Strainers must be used together with flowmeters.  
We have various sizes to suit all flowmeters.

### Model numbers

Base code	Size (mm / inch)		Max. Flowrate (m <sup>3</sup> / h)	Max. Pressure	Material
FSYB426BAP	15	1/2	0.4	1MPa	Body: FC250 Screen: SUS304
FSBB632BAP	20	3/4	2		
FSBB839DAP	25	1	10	2MPa	
FSB0439DAP	40	1 1/2	10		
FSB0542BAP	50	2	20	1MPa	
FSB0848BAP	80	3	80		
FSB1051BAP	100	4	150		

### Standard Specifications

Size		15mm (1/2 B) ~ 150mm (6B)
Max. working pressure		BAP : 1Mpa, DAP : 2MPa
Flange rating		BAP : JIS10K, DAP : JIS20K
Material	Body	FC250 or STPG370
	Screen	SUS304
	Gasket	Non-asbestos, teflon
Screen	80 mesh	Viscosity less than 10mPa·s
	40 mesh	Viscosity more than 10mPa·s
	200 mesh	FSYB426BAP

### Dimensions

Model number	Size		Dimensions				Approx. weight
	(mm)	(inch)	L	H	H1	φB	
FSYB426BAP	15	1/2	125	---	70	---	2
FSBB632BAP	20	3/4	180	147	110	62	7
FSBB839DAP	25	1	295	258	163	160	15
FSB0439DAP	40	1 1/2	295	258	163	160	16
FSB0542BAP	50	2	320	290	185	185	22
FSB0848BAP	80	3	395	373	252	230	41
FSB1051BAP	100	4	460	480	325	295	67

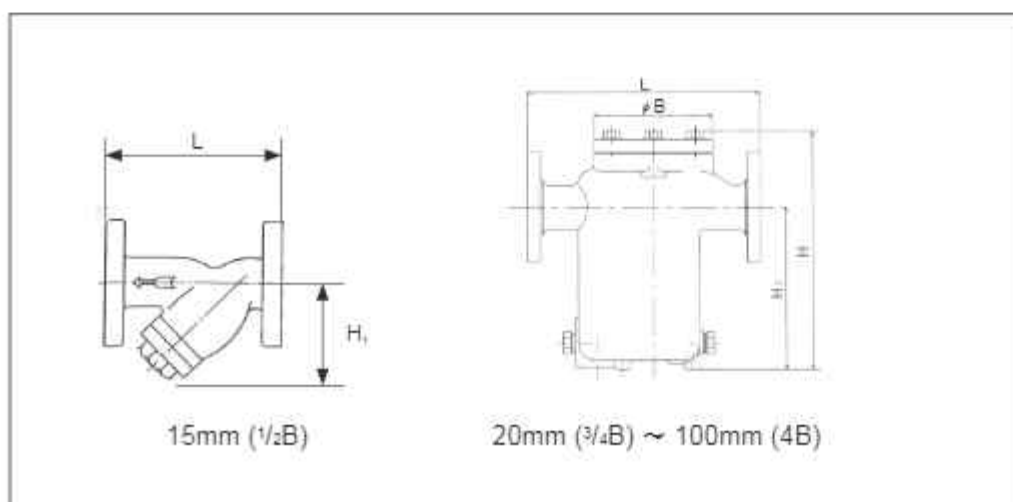

## Precautions on piping and operation

- (1) Dirt and particles inside the piping cause problem to the flowmeter. Take special care when installing to new piping, since new piping may have welding debris.
- (2) A strainer must be installed at the up-stream of the flowmeter, as shown in below figure. This is to prevent the problem stated in (1) above. Also, prepare a by-pass line for the convenience of flowmeter disassembly and maintenance.
- (3) Indicator must be installed at eye level and must not face upwards.
- (4) Make sure to align actual flow direction with flowmeter's flow direction.
- (5) Use the flowmeter within the specification written on the name plate.

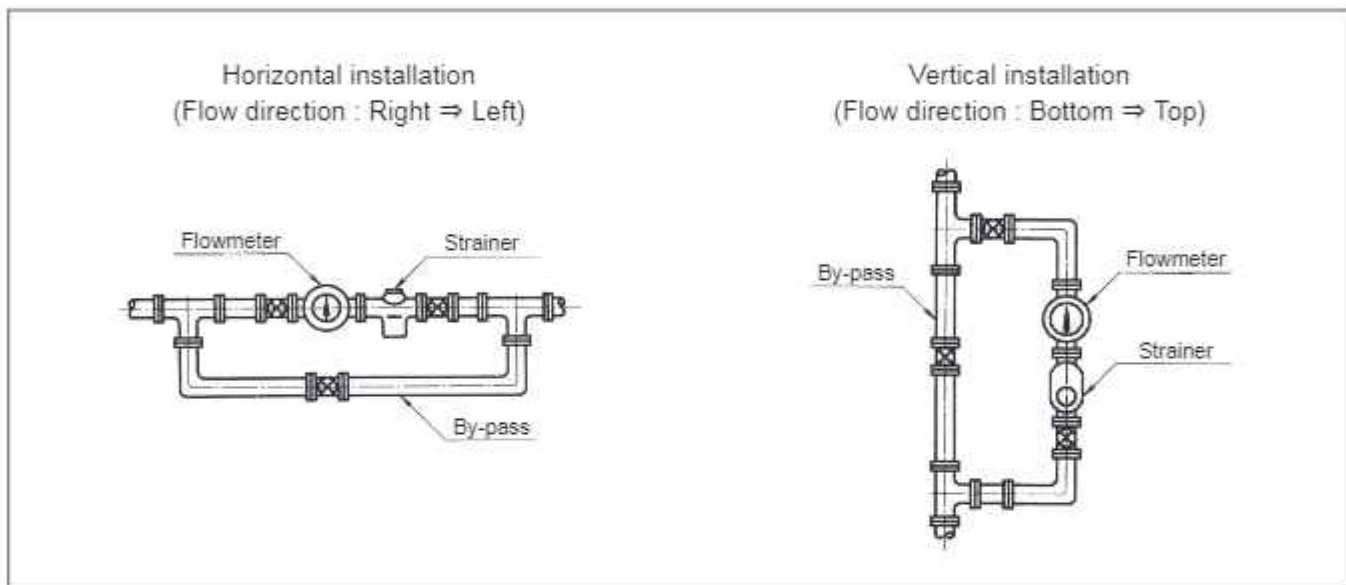

## Inquiry

Please inform us the following when quotation is necessary.

No.	Item	Contents
1	Application	Production control, transaction, receipt and shipment, etc.
2	Fluid	Name, composition, corrosive or not
3	Flow rate	Maximum, normal, minimum
4	Fluid temperature	Maximum, normal, minimum
5	Fluid pressure	Maximum, normal, minimum
6	Viscosity and specific gravity	Viscosity at °C, Specific gravity at °C
7	Connection rating	Connection size, flange standard, etc.
8	Flow direction	Left ⇒ Right, Right ⇒ Left, Bottom ⇒ Top, Top ⇒ Bottom

\* Dimensions and specifications on this catalog are subject to change without prior notice.