

CONTOIL®

Fuel oil meters

Applications

- Flow measurement for mineral oils and heating or propellant fuels
- In burners, on board ships, land vehicles and fixed-position motors
- “Germanischer Lloyd” approval for use on board ships (option)



Features

- The complete range of products offering the best solutions for the measurement of oil consumption
- Flow display for the electronic totalizer
- Mounting on the pressure or suction side, with no straight inlets or outlets required
- Independent of viscosity and temperature
- High vibration resistance

Your benefits

- The reliable solution with everything from a single source
- Simplifying burner settings
- Highly flexible mounting with very low space requirements
- Accurate measurements
- Maximum safety in the shipbuilding and automobile industries

The right product for every application...

VZE 15 ... 50 range (Standard)



with multi-function display and remote transmission

Electronic display of

- total volume
- resettable volume
- flow rate in l/h in digitals and as bar diagram in % other operating data in the service level

Simple to operate

Normal commercial long-life battery, simple to change, data security



Option: Inductive INA pulser for control purposes

Housing with threaded or flanged connection

Main characteristic data:

- flow range 10 ... 30,000 l/h
- temperature 70, 130 and 180° C
- nominal pressure PN 16 and PN 25 bar

Information in chapter 1

Page 5

VZO 4 ... 50 range (Classic)



total volume display and remote transmission

Total volume display on roller register

Option: Reed pulser RE or RV for remote totalisation

Option: Inductive IN pulser for control purposes

Housing with threaded or flanged connection



Main characteristic data:

- flow range 0.5 ... 30,000 l/h
- temperature 60, 130 and 180° C
- nominal pressure PN 16, PN 25 and PN 40 bar



Information in chapter 2

Page 8

... product groups and selection criteria

VZEA/VZOA range



optimal solution for special applications as for:

- differential measurement (VZEA/VZOA 15...50)
- certification/custody transfer for commercial transactions (VZOA 4 ...50)
- engine testbenches (VZEA/VZOA 15...50)

VZEA

Electronic display of

- total volume
- resettable volume
- flow rate in l/h in digitals and as bar diagram in % other operating data in the service level

VZOA 4 and 8

- Volume display on roller register

VZOA 15...50

- Volume display on roller register

Option: Inductive pulser, INA or IN, for control purposes

Option: RV Reed pulser for remote totalisation, integrated into the roller register (VZOA)

Housing with threaded or flanged connection

Main characteristic data:

- flow range 10 ... 30,000 l/h
- temperature 130 and 180° C
- nominal pressure PN 16 and PN 25 bar

with special pairing for minimum measurement variance.

Information in chapter 3

Page 16

Accessories

Chapter 4

Page 22

Meter data (Appendix)

Chapter 5

Page 23

Selection of the optimal meter

Chapter 6

Page 30

Fluid fuel oil

Chapter 7

Page 31

How to obtain an optimal measurement

Chapter 8

Page 32

Application examples

Chapter 9

Page 37



If flowmeters are needed for hazardous areas, please contact your nearest sales office.

CONTOIL[®], the world's most frequently-used oil consumption meter

Leading manufacturers of oil burners and operators of heating systems, ships or diesel engines rely on CONTOIL[®] fuel oil meters - and with good reasons.

The advantages of CONTOIL[®] fuel oil meters – your benefits

You can decide which of these many benefits are the most important for you:

- the optimal solution for every application
- simple burner setting with flow rate display (types VZE)
- simple consumption monitoring or manual dosing feature, with the resettable counter (types VZE)
- can be mounted on the pressure or suction side
- space-saving installation, because no straight inlet/outlet sections are needed
- the meter can be mounted flexibly in a horizontal, vertical or inclined position
- accurate measurement result, since the reading is independent of the temperature and viscosity of the fluid
- minimum failure costs due to simple function monitoring, rapid fault analysis and the possibility of simple repairs on site

Areas of use

- to measure heating fuel consumption by oil burners (for example, in heating boilers, industrial furnaces, tar processing plants)
- to measure propellant fuel consumption by motors and engines (such as diesel locomotives, construction machinery and ships, or in standby power groups, combined heating and power stations)
- consumption monitoring
- flow measurement for mineral oils, option with remote transmission
- manual dosing / filling
- flow measurement for machine and motor/engine oils
- engine testbenches

Medium

- heating fuel extra light / light, medium, heavy
 - naphtha
 - diesel
 - petrol
- and other media which can be used for lubrication purposes

VZE 15...50 (Standard)

Technical data 1)



- with electronic display of total volume, resettable volume and flow rate, units: litres or US gallons ²⁾
- fuel oil meter with threaded or flanged connection
- for mounting in a horizontal, vertical or inclined position

Option: with inductive INA pulser

Versions available on request:

- different flange drillings, such as ANSI, JIS

Type			VZE 15	VZE 20	VZE 25	VZE 40	VZE 50	
Nominal diameter	DN	mm	15	20	25	40	50	
		inch	1/2	3/4	1	1 1/2	2	
Installation length		mm	165	165	190	300	350	
Nominal pressure with threaded ends	PN	bar	16					
with flanges	PN	bar	25					
Maximum temperature		°C	70, 130, 180					
Maximum flow rate	Q _{max} ³⁾	l/h	600	1500	3000	9000	30000	
Nominal flow rate	Q_n ³⁾	l/h	400	1000	2000	6000	20000	
Minimal flow rate	Q _{min}	l/h	10	30	75	225	750	
Approx. starting flow rate		l/h	4	12	30	90	300	
Max. permissible error	± 1% of actual value							
Repeatability	± 0,2%							
Smallest readable amount:	No decimals							
Total volume	l	3 decimal places with floating decimal point						
Resettable volume	l	1 decimal place						
Digital flow rate display	l/h	100 000 000						
Registration capacity	approx. l							
Registration at Q _n before return to zero	h	250 000	100 000	50 000	16 660	5 000		
Safety filter mesh width	mm	0,400	0,400	0,400	0,800	0,800		
Dirt trap mesh width	mm	0,250	0,400	0,400	0,600	0,600		
Volume of the measuring chamber	approx. cm ³	12	36	100	330	1200		
Housing finish	enamelled red RAL 3013							
Weight with threaded ends ⁴⁾	approx. kg	2,2	2,5	4,2	17,3	–		
with flanges PN 25	approx. kg	3,8	4,5	7,5	20,3	41,0		
Pulse values of pulsers:	approx.							
INA inductive according to DIN 19234 ⁵⁾	l/pulse	0.0006	0.00185	0.005	0.017	0.060		
Pulse frequency INA	at Q _{max}	Hz	277,778	225,225	166,667	147,059	138,889	
	at Q _{min}	Hz	4,630	4,505	4,167	3,676	3,472	

1) Manufacturer's specification, valid for the reference condition as specified under meter data (annex).

2) 1 US gallon corresponds to 3.785 litres.

3) For burners and engines or motors, the meter must basically be selected for permanent flow. For higher viscosity, or if the meter is installed on the suction side, the pressure drop and any reduction in the measuring range must also be considered; see Chapters 5 and 8.

4) Weight without couplings.

5) The precise pulse value can be taken from the meter; it is only known after the calibration. The next device must have an adjustable input.

Pressure drop curves

in chapter 5

Electronic display

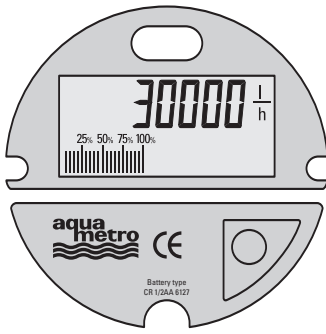

66017.4a

- Display values:
- total volume, resettable volume, flow rate
 - In the service level, service hours and other information can be read out
- Display:
- 8-character LCD with identification of the parameter, height of numbers: 8 mm, flow rate (meter load) using bar diagram
- Temperature:
- ambient temperature -10 ... +70° C, storage temperature -20 ... +80° C
- Safety:
- CE, vibration and shock test to DIN IEC 68
- Supply:
- usual commercial lithium battery, type CR 1/2AA or CR2
- Data reception:
- by non-volatile memory (EEPROM)
- Change of battery:
- after 5 years, based on a battery lifetime of 6 years with a maximum of 10 hours' digital display of the flow rate
- Protection:
- IP54 (IEC 144) against splash water and dust

Dimensions in mm

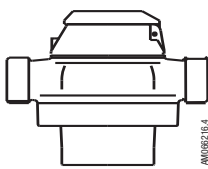
	Meter	Length	Width	Height of meters VZE			
				VZE ... 70° C		VZE ... 130° C and 180° C	
				L	W	-INA	
						H	H
VZE 15	165	105	106	147	185	185	
VZE 20	165	105	115	156	194	194	
VZE 25	190	130	142	183	221	221	
VZE 40	300	210	194	235	273	273	
VZE 50	350	280	250	291	329	329	

Detailed dimensional drawings in chapter 5

INA pulsers

High-resolution pulsers for industrial applications. Plug-in proximity switch.

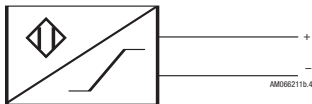

- Switching element:
- inductive slot initiator according to DIN 19234
- Switching voltage:
- 5 ... 15 VDC
- Residual ripple:
- max. 5%
- Switching current:
- > 3 mA at 8 VDC / 1 kOhm
- Static current:
- < 1 mA at 8 VDC / 1 kOhm
- ON-time:
- 50% ± 10%
- Ambient temperature:
- -10 ... +70° C
- Type of protection:
- IP 65 (IEC 144) against water jets and dust
- Connection:
- Pulser supplied with special plug. Required cable min. 2 x 0.35 mm² and 4...6 mm external diameter or optional pn 80019 with mounted cable.
- Option:
- Cable mounted, 2 x 0.5 mm², PVC black, length 3 m (pn 80019)

Type designation key

VZE 25 FL 130/25-INA

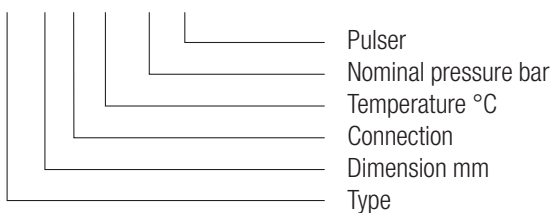

Ordering specifications

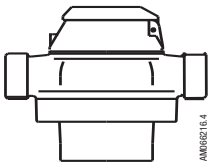
Threaded ends 	Type	Order No.	Type	Order No.
	VZE 15 RC 70/16	92206	VZE 25 RC 70/16	92224
VZE 15 RC 70/16-INA ¹⁾	92207	VZE 25 RC 70/16-INA ¹⁾	92225	
VZE 15 RC 130/16	92208	VZE 25 RC 130/16	92226	
VZE 15 RC 130/16-INA ¹⁾	92209	VZE 25 RC 130/16-INA ¹⁾	92227	
VZE 20 RC 70/16	92214	VZE 40 RC 70/16	92234	
VZE 20 RC 70/16-INA ¹⁾	92215	VZE 40 RC 70/16-INA ¹⁾	92235	
VZE 20 RC 130/16	92216	VZE 40 RC 130/16	92236	
VZE 20 RC 130/16-INA ¹⁾	92217	VZE 40 RC 130/16-INA ¹⁾	92237	

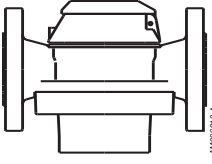
Flanges 130° C / PN 25 	Type	Order No.	Type	Order No.
	VZE 15 FL 130/25	92212	VZE 40 FL 130/25	92240
VZE 15 FL 130/25-INA ¹⁾	92213	VZE 40 FL 130/25-INA ¹⁾	92241	
VZE 20 FL 130/25	92220	VZE 50 FL 130/25	92246	
VZE 20 FL 130/25-INA ¹⁾	92221	VZE 50 FL 130/25-INA ¹⁾	92247	
VZE 25 FL 130/25	92230			
VZE 25 FL 130/25-INA ¹⁾	92231			

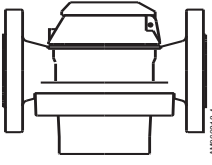
Flanges 180° C / PN 25 	Type	Order No.	Type	Order No.
	VZE 20 FL 180/25	92222	VZE 40 FL 180/25	92242
VZE 20 FL 180/25-INA ¹⁾	92223	VZE 40 FL 180/25-INA ¹⁾	92243	
VZE 25 FL 180/25	92232	VZE 50 FL 180/25	92248	
VZE 25 FL 180/25-INA ¹⁾	92233	VZE 50 FL 180/25-INA ¹⁾	92249	

DN 15 only when the plant has a dirt trap with a max. 0.1 mm mesh width.

Option / Accessory ¹⁾

Cable	Mounted cable IN/INA	80019
-------	----------------------	-------

VZO 4...50 (Classic)

VZO 4 and 8

Technical data 1)



- oil meter with inside thread connections located on the bottom plate
- with mechanical roller counter, volume display in litres
- meters in US-Gallons 2)
- for mounting in horizontal, vertical and inclined positions
- VZOA 4 and 8 with approval / custody transfer

Option: Reed pulser 48 V

Type		VZO 4 Q _{min} 0,5	VZO 4	VZO 8
Nominal diameter	mm	4	4	8
	inch	1/8	1/8	1/4
Connection threads of meter	inch	1/8	1/8	1/4
Nominal pressure	bar	25		
Temperature	°C	60		
Maximum flow rate	Q _{max} 3) I/h	40	80	200
Nominal flow rate	Q_n 3) I/h	25	50	135
Minimal flow rate	Q _{min} 4) I/h	0,5	1	4
Approx. starting flow rate	I/h	0,3	0,4	1,6
Max. permissible error		± 1% of actual value 4)		
Repeatability		± 0,2%		
Smallest readable amount	l	0,001	0,001	0,01
Registration capacity	m ³	100	100	1000
Registration at Q _n before return to zero	h	4000	2000	7400
Safety filter mesh width	mm	0,125	0,125	0,150
Dirt trap mesh width	mm	0,080	0,080	0,100
Volume of the measuring chamber	approx. cm ³	5	5	12,5
Weight without couplings	approx. kg	0,65	0,65	0,75
Reed pulsers	RE 1 RE 0,1 RE 0,01 RE 0,00125 RE 0,00311	I/pulse	– – – – –	1 0,1 0,01 0,00125 0,00311
Pulse frequency for	RE 0,00125 5) at Q _{max}	Hz	–	17,777
	at Q _{min}	Hz	–	0,222
Pulse frequency for	RE 0,00311 5) at Q _{max}	Hz	–	17,864
	at Q _{min}	Hz	–	0,357

1) Manufacturer's specification, valid for the reference condition as specified under meter data (annex).

2) 1 US gallon corresponds to 3.785 litres

3) For burners and engines or motors, the meter must basically be selected for permanent flow. For higher viscosity, or if the meter is installed on the suction side, the pressure drop and any reduction in the measuring range must also be considered; see Chapters 5 and 8.

4) Max. permissible error: VZO 4 Q_{min} 0,5: 0,5 I/h ... 2 I/h = + 1% / - 2%. VZO 4: 1 I/h ... 2 I/h = + 1% / - 2%.

5) Brief intervals when switched on have to be considered.

VZOA 4 and 8 with approval

Technical data for VZOA with PTB approval: 5.232 / 04.37 Class 1

Data according to approval specifications		VZOA 4	VZOA 8
Temperature max.		°C	
		60	60
Maximum flow rate	Q _{max} 3) I/h	20	140
Nominal flow rate	Q_n 3) I/h	20	140
Minimal flow rate	Q _{min} 4) I/h	2	14
Max. permissible error	± % of actual value	0.5	0.5

Technical data for VZOA with approval / EU custody transfer D 04/5.232.14

Data according to approval specifications		VZOA 4	VZOA 8
Temperature max.	° C	50	50
Maximum flow rate	$Q_{max}^{3)}$ l/h	20	140
Nominal flow rate	$Q_n^{3)}$ l/h	20	140
Minimal flow rate	$Q_{min}^{4)}$ l/h	2	14
Max. permissible error	± % of actual value	0.5	0.3

Two items are required when ordering: the VZOA counter and EU custody transfer, Article No. 96026.

Pressure drop curves

in chapter 5

Dimensions in mm

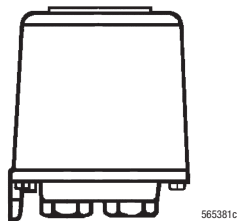

565381c

height = 79
width = 65
depth = 65

Dial

VZO 4

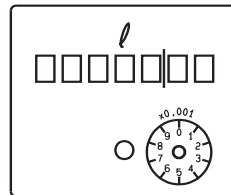

66144a

VZO 8

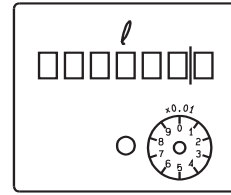

66144b

Detailed dimensional drawings in chapter 5

Mouting kit for VZO 8

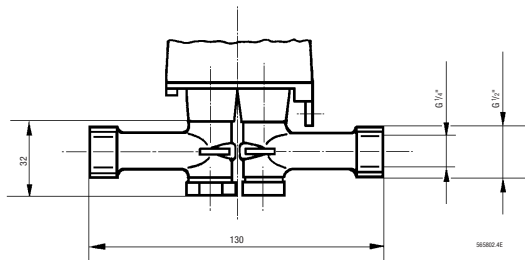

Order No. 81130: some possible mounting positions

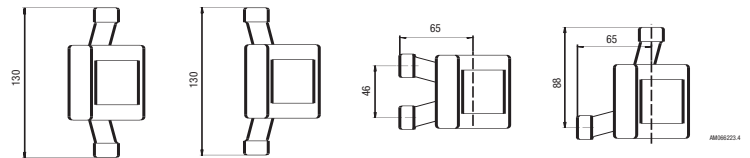

AM060221.4

RE Pulsers

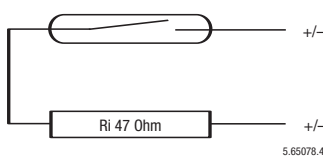

5.65078.4

Switching element:
Switching voltage:
Switching current:
Static current:
Switching power:
ON-time:

- Reed switch with dry contact (inert gas)
- Max. 48 V AC/DC
- Max. 50 mA
- Open Contact
- Max. 3 VA
- VZO 4-RE 0.00125: 65...90 %
- VZO 4-RE 0.01: 10...30 %
- VZO 4-RE 1: 30...70 %
- VZO 8-RE 0.00311: 65...90 %
- VZO 8-RE 0.1: 10...30 %
- VZO 8-RE 1: 30...70 %

Temperature:
Protection:

- Ambient -10 ... +60° C

Meters without pulser:

- IP 65 (IEC 144) against water-jets and dust

Meters with pulser RE:

- IP 50 (IEC 144) against dust deposits

Connection:

- On plug supplied with product for cable, 2 × 0,35 mm²

Ordering specifications

Type	Order No.	Type	Order No.
VZO 4	92680	VZO 8	92630
VZO 4 RE 0,00125	89763	VZO 8 RE 0,00311	89733
VZO 4 RE 0,01	89760	VZO 8 RE 0,1	89730
VZO 4 RE 0,1	89761	VZO 8 RE 1	89731
VZO 4 Q _{min} 0,5	92678		
VZOA 4	93162	VZOA 8	93163

Modifications / Options

Modification	with EU custody transfer	96026
--------------	--------------------------	-------

Special versions with gaskets FMP fluoroelastomer

VZO 4 V	Order No. 92487
VZO 4 V - RE 0,01	Order No. 92488
VZO 4 V - RE 0,1	Order No. 92489

VZO 4 and 8 OEM

Technical data 1)



- fuel oil meters for OEMs (original equipment manufacturers), to be mounted under the burner cover
- meters with internal threaded connection, positioned laterally
- with 230V Reed pulser to display measurement values on remote totaliser or on burner control unit
- for mounting in horizontal, vertical or inclined positions

Type		VZO 4 OEM	VZO 8 OEM	
Nominal diameter	mm	4	8	
	inch	1/8	1/4	
Connection threads of meter	inch	1/8	1/4	
Nominal pressure	bar	32	25	
Temperature	° C	60	60	
Maximum flow rate	$Q_{max}^{2)}$ l/h	80	200	
Nominal flow rate	$Q_n^{2)}$ l/h	50	135	
Minimal flow rate	$Q_{min}^{3)}$ l/h	1	4	
Approx. starting flow rate	l/h	0,4	1,6	
Max. permissible error		± 1% of actual value ³⁾		
Repeatability		± 0,2%		
Safety filter mesh width	mm	0,125	0,150	
Dirt trap mesh width	mm	0,080	0,100	
Volume of the measuring chamber	approx. cm ³	5	12,5	
Weight	approx. kg	0,65	0,75	
Reed pulsers	RE	l/pulse	0,005	0,0125
Pulse frequency	at Q_{max}	Hz	4,444	4,444
	at Q_{min}	Hz	0,056	0,089

1) Manufacturer's specification, valid for the reference condition as specified under meter data (annex).

2) For burners and engines or motors, the meter must basically be selected for permanent flow. For higher viscosity, or if the meter is installed on the suction side, the pressure drop and any reduction in the measuring range must also be considered; see Chapters 5 and 8.

3) Max. permissible error: VZO 4 OEM: 1 l/h ... 2 l/h = + 1%/- 2%.

Pressure drop curves

in chapter 5

Dimensions in mm

VZO 4 OEM

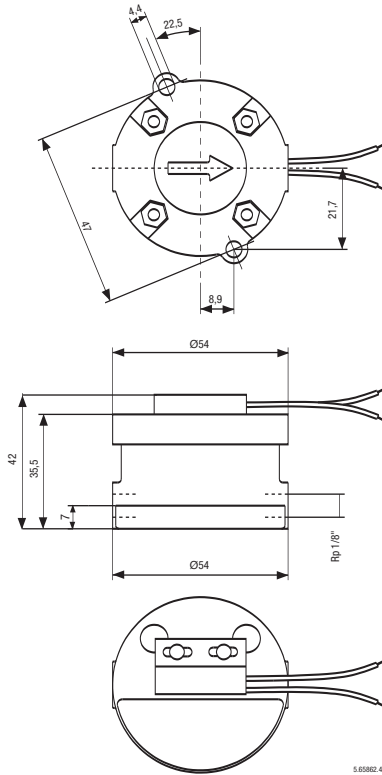

VZO 8 OEM

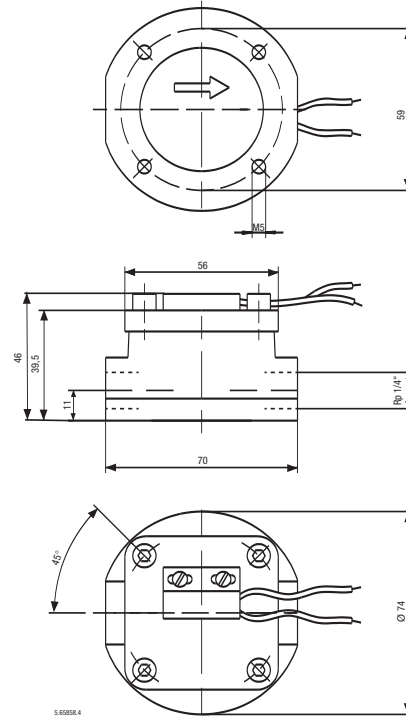

RE Pulsers

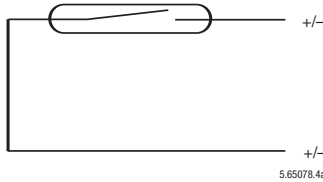

Switching element:
Switching voltage:
Switching current:
Static current:
Switching power:
ON-time:
Temperature:
Protection:
Connection:

- Reed switch with dry contact (inert gas)
- max. 230 V AC/DC
- max. 50 mA
- Open Contact
- max. 3 VA
- 40 ... 55%
- Ambient $-10 \dots +60^{\circ}\text{C}$
- IP 65 (IEC 144) against water-jets and dust
- Cable cross section $2 \times 0,5 \text{ mm}^2$, length 480 mm

Remote totaliser for VZO 4 OEM



Power supply:
Pulse value (input):
Smallest readable amount:
Registration capacity:
Registration:
Panel cut-out:
Installation depth:

- 230 V, 50/60 Hz
- 0,005 l
- 0,005 l
- 10 000 l
- at Q_n before return to zero 200 h
- $27 \times 14,4 - 0/+ 0,2 \text{ mm}$
- 56 mm

Ordering specifications

	Type	Description	Order No.
	VZO 4 OEM-RE 0,005	Version for OEMs Remote totaliser for VZO 4 OEM	89765 93349
	VZO 8 OEM-RE 0,0125	Version for OEMs	89771

VZO 15 ... 50

Technical data ¹⁾



- Volume display on roller register, in litres
- fuel oil meter with threaded or flanged ends
- for horizontal, vertical or inclined mounting

Option: Reed pulser or RV / IN pulser

Versions available on request:

- different flange drillings, such as ANSI, JIS
- meters in US gallons ²⁾ (option)

Type			VZO 15	VZO 20	VZO 25	VZO 40	VZO 50
Nominal diameter	DN	mm	15	20	25	40	50
		inch	1/2	3/4	1	1 1/2	2
Installation length		mm	165	165	190	300	350
Nominal pressure with threaded ends with flanges	PN	bar	16				
	PN	bar	25, 40				
Maximum temperature		° C	130, 180				
Maximum flow rate	Q _{max} ³⁾	l/h	600	1500	3000	9000	30000
Nominal flow rate	Q_n ³⁾	l/h	400	1000	2000	6000	20000
Minimal flow rate	Q _{min}	l/h	10	30	75	225	750
Approx. starting flow rate		l/h	4	12	30	90	300
Max. permissible error	± 1% of actual value						
Repeatability	± 0,2%						
Smallest readable amount		l	0,01	0,1	0,1	0,1	1
Registration capacity		m ³	1000	10 000	10 000	10 000	100 000
Registration at Q _n before return to zero		h	2500	10 000	5000	1667	5000
Safety filter mesh width		mm	0,400	0,400	0,400	0,800	0,800
Dirt trap mesh width		mm	0,250	0,400	0,400	0,600	0,600
Volume of the measuring chamber		approx. cm ³	12	36	100	330	1200
Housing finish	enamelled red RAL 3013						
Weight with threaded ends ⁴⁾		approx. kg	2,2	2,5	4,2	17,3	–
	with flanges PN 25	approx. kg	3,8	4,5	7,5	20,3	41,0
	with flanges PN 40	approx. kg	4,4	5,5	7,8	20,5	42,0
Pulse values of pulsers:							
IN inductive according to DIN 19234		l/pulse	0,01	0,01	0,1	0,1	1
RV Reed		l/pulse	0,1	1	1	1	10
RV Reed		l/pulse	1	–	–	10	100
Pulse frequency IN	at Q _{max}	Hz	16,667	41,667	8,333	25,000	8,333
	at Q _{min}	Hz	0,278	0,833	0,208	0,625	0,208

1) Manufacturer's specification, valid for the reference condition as specified under meter data (annex).

2) 1 US gallon corresponds to 3.785 litres

3) For burners and engines or motors, the meter must basically be selected for permanent flow. For higher viscosity, or if the meter is installed on the suction side, the pressure drop and any reduction in the measuring range must also be considered; see Chapters 5 and 8.

4) Weight without couplings.

Pressure drop curves

in chapter 5

Dimensions in mm

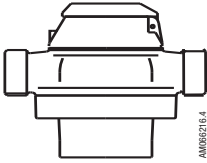
	Meter	Length	Width	Height of meters VZO					
				VZO ... 130° C			VZO ... 180° C		
					-RV	-IN		-RV	-IN
				L	W	H	H	H	H
VZO 15	165	105	106	130	185	147	171	225	
VZO 20	165	105	115	139	194	156	180	234	
VZO 25	190	130	142	166	221	183	207	261	
VZO 40	300	210	235	259	273	235	259	313	
VZO 50	350	280	291	315	329	291	315	369	

Detailed dimensional drawings see chapter 5

RV Pulsers

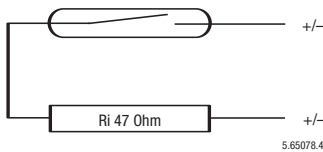

This pulser is integrated into the roller counter and is thus especially appropriate for remote totalisation. For other applications the use of the inductive pulser IN is preferable.

- | | |
|----------------------|---|
| Switching element: | • Reed switch with dry contact (inert gas) |
| Switching voltage: | • max. 48 V AC/DC |
| Switching current: | • max. 50 mA (Ri = 47 Ohm/0,5 W) |
| Static current: | • Open Contact |
| Switching power: | • max. 2 W |
| ON-time: | • 50% ± 10% |
| Temperature: | • Ambient -10 ... +70° C |
| Protection: | • IP 65 (IEC 144) against water-jets and dust |
| Connection: | • Cast-in cable, length 3 m |
| Cable cross section: | • 2 × 0,14 mm ² |

IN Pulsers

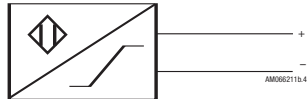

Pulser for industrial applications. Supplied with plug-in pulser sensor.

- | | |
|--------------------|---|
| Switching element: | • Slot initiator according to DIN 19234 |
| Switching voltage: | • 5 ... 15 V DC |
| Residual ripple: | • max. 5% |
| Switching current: | • > 3 mA bei 8 V DC / 1 kOhm |
| Static current: | • < 1 mA bei 8 V DC / 1 kOhm |
| ON-time: | • 50% ± 10% |
| Temperature: | • Ambient -10 ... +70° C |
| Protection: | • IP 65 (IEC 144) against water-jets and dust |
| Connection: | • Pulser supplied with special plug. Required cable min. 2 x 0.35 mm ² and 4...6 mm external diameter or optional pn 80019 with mounted cable. |
| Option: | • Cable mounted, 2 x 0.5 mm ² , PVC black, length 3 m (pn 80019) |

Type designation key

VZO 25 FL 130/25-IN ...

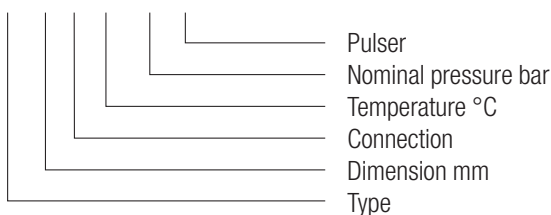

Ordering specifications

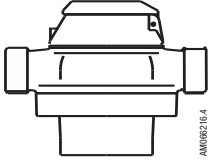
Threaded ends	Type	Order No.	Type	Order No.
 <small>AM08E216.4</small>	VZO 15 RC 130/16	92041	VZO 25 RC 130/16	92057
	VZO 15 RC 130/16-RV 0,1	92042	VZO 25 RC 130/16-RV 1	92058
	VZO 15 RC 130/16-RV 1	92043	VZO 25 RC 130/16-IN 0,1 ¹⁾	91913
	VZO 15 RC 130/16-IN 0,01 ¹⁾	91900		
	VZO 20 RC 130/16	92047	VZO 40 RC 130/16	92004
	VZO 20 RC 130/16-RV 1	92048	VZO 40 RC 130/16-RV 1	92018
	VZO 20 RC 130/16-IN 0,01 ¹⁾	91902	VZO 40 RC 130/16-IN 0,1 ¹⁾	91906

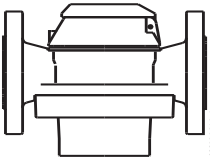
Flanges 130° C / PN 25	Type	Order No.	Type	Order No.
 <small>AM08E216.4</small>	VZO 15 FL 130/25	92044	VZO 40 FL 130/25	92005
	VZO 15 FL 130/25-RV 0,1	92045	VZO 40 FL 130/25-RV 1	92020
	VZO 15 FL 130/25-RV 1	92046	VZO 40 FL 130/25-IN 0,1 ¹⁾	91907
	VZO 15 FL 130/25-IN 0,01 ¹⁾	91910		
	VZO 20 FL 130/25	92049	VZO 50 FL 130/25	92007
	VZO 20 FL 130/25-RV 1	92050	VZO 50 FL 130/25-RV 10	92024
	VZO 20 FL 130/25-IN 0,01 ¹⁾	91903	VZO 50 FL 130/25-IN 1 ¹⁾	91909
	VZO 25 FL 130/25	92059		
	VZO 25 FL 130/25-RV 1	92060		
	VZO 25 FL 130/25-IN 0,1 ¹⁾	91914		

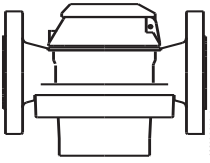
Flanges 180° C / PN 25	Type	Order No.	Type	Order No.
 <small>AM08E218.4</small>	VZO 15 FL 180/25	92250	VZO 40 FL 180/25	92274
	VZO 15 FL 180/25-RV 0,1	92251	VZO 40 FL 180/25-RV 1	92275
	VZO 15 FL 180/25-RV 1	92252	VZO 40 FL 180/25-IN 0,1 ¹⁾	92276
	VZO 15 FL 180/25-IN 0,01 ¹⁾	92253		
	VZO 20 FL 180/25	92258	VZO 50 FL 180/25	92280
	VZO 20 FL 180/25-RV 1	92259	VZO 50 FL 180/25-RV 10	92281
	VZO 20 FL 180/25-IN 0,01 ¹⁾	92260	VZO 50 FL 180/25-IN 1 ¹⁾	92282
	VZO 25 FL 180/25	92264		
	VZO 25 FL 180/25-RV 1	92265		
	VZO 25 FL 180/25-IN 0,1 ¹⁾	92266		

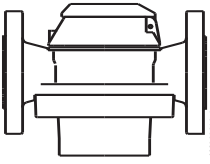
Flanges 180° C / PN 40	Type	Order No.	Type	Order No.
 <small>AM08E218.4</small>	VZO 15 FL 180/40	92254	VZO 40 FL 180/40	92277
	VZO 15 FL 180/40-RV 0,1	92255	VZO 40 FL 180/40-RV 1	92278
	VZO 15 FL 180/40-RV 1	92256	VZO 40 FL 180/40-IN 0,1 ¹⁾	92279
	VZO 15 FL 180/40-IN 0,01 ¹⁾	92257		
	VZO 20 FL 180/40	92261	VZO 50 FL 180/40	92283
	VZO 20 FL 180/40-RV 1	92262	VZO 50 FL 180/40-RV 10	92284
	VZO 20 FL 180/40-IN 0,01 ¹⁾	92263	VZO 50 FL 180/40-IN 1 ¹⁾	92285
	VZO 25 FL 180/40	92267		
	VZO 25 FL 180/40-RV 1	92268		
	VZO 25 FL 180/40-IN 0,1 ¹⁾	92269		

DN 15 only when the plant has a dirt trap with a max. 0.1 mm mesh width.

Option / Accessory ¹⁾

Cable	Mounted cable IN/INA	80019
-------	----------------------	-------

VZEA/VZOA 15...50, products for special requirements / applications

For applications requiring an increased accuracy of $\pm 0,5\%$ or better, as i.e.:

- Measurement of heating fuel EL or diesel in testing facilities
- Differential measurement
- Custody transfer with legal verification, when the counters are legally required to have design approval or custody transfer.

These products require strainers with smaller mesh size.

Products for the differential measurement

For a differential measurement, the flow is measured in the supply and return pipes. The difference between the two measurements is regarded as the consumption.

To obtain optimal measurement results, you should only use VZEA or VZOA CONTOIL® fuel oil meters calibrated in pairs, which are co-ordinated precisely to the plant/system operating conditions. The flow rate occurring in each meter, the permissible pressure drop and the viscosity of the fluid must all be considered during the design phase. The load on the meter is obtained as follows: flow in supply section less consumption = flow in return section.

When the order is placed, the following information is required:

- application e.g. differential measurement for diesel engines in a standby power group
- fluid e.g. diesel fuel
- temperature e.g. 15 ... 40° C
- operating pressure e.g. 4 bar
- flow rate in supply section e.g. fixed pumping rate 200 l/h
- flow rate in return section e.g. 120 ... 190 l/h (for a consumption of 10 ... 80 l/h)

The meters are marked "supply" and "return" during calibration and final testing in the factory. They must then be installed in the correct pipes.

For further information on the subject of differential measurement, please see Chapter 8, System Planning and Chapter 9, Application Examples.

Versions with design approval or custody transfer

CONTOIL® fuel oil meters are used almost exclusively for the measurement of the consumption of fuel oil. The metrological standards (such as the MID or EC guideline 71/319/EEC) are, however, regulate the requirements for counters and systems used for commercial transactions as well as the procedures for design approval and custody transfer. Measuring sites where a fluid is sold are regarded as transfer points that require custody transfer. These include petrol pumps at petrol stations, measuring devices for road tankers and measuring stations for loading and unloading all types of road vehicles. As a rule, a metering system on site must be in standby power mode and be checked and sealed by the local office responsible for custody transfer.

Typical for these applications is the narrow operating range with regard to the product, flowrate and temperature. CONTOIL® fuel oil meters are also available within the metrological for design approval or custody transfer. The differences in products relate only to the design or specifications of the counter and not to the quality of the product.

Technical data ¹⁾



- Product versions for optimal results from differential measurement or for custod transfer (option)
- VZEA with electronic display of total volume, resettable volume, and flow rate, units: litres or US gallons ²⁾
- VZOA with display of total volume on roller register, units: litres.
Optional versions with display in US gallons
- VZEA option: with inductive INA pulser
- VZOA option: with reed or inductive pulser, RV or IN
- with threaded or flanged connection
- for mounting in horizontal, vertical or inclined positions

Versions available on request:

- different flange drillings, such as ANSI, JIS

Type		VZEA/ VZOA	VZEA/ VZOA	VZEA/ VZOA	VZEA/ VZOA	VZEA/ VZOA	
		15	20	25	40	50	
Nominal diameter	DN	mm	15	20	25	40	50
		inch	1/2	3/4	1	1 1/2	2
Installation length		mm	165	165	190	300	350
Nominal pressure with threaded ends	PN	bar			16		
with flanges	PN	bar			25		
Maximum temperature		° C			130, 180		
Maximum flow rate	Q _{max} ³⁾	l/h	600	1500	3000	9000	30000
Nominal flow rate	Q_n ³⁾	l/h	400	1000	2000	6000	20000
Minimal flow rate	Q _{min}	l/h	10	30	75	225	750
Approx. starting flow rate		l/h	4	12	30	90	300
Max. permissible error			< 0.5% of actual value				
Repeatability			± 0,1%				
VZEA							
Smallest readable amount:							
Total volume		l	No decimals				
Resettable volume		l	3 decimal places with floating decimal point				
Digital flow rate display		l/h	1 decimal place				
Registration capacity		approx. l	100 000 000				
Registration at Q _n before return to zero		h	250 000	100 000	50 000	16 660	5 000
VZOA							
Smallest readable amount		l	0,01	0,1	0,1	0,1	1
Registration capacity		m ³	1000	10 000	10 000	10 000	100 000
Registration at Q _n before return to zero		h	2 500	10 000	5 000	1 667	5 000
Safety filter mesh width		mm	0,400	0,400	0,400	0,800	0,800
Dirt trap mesh width		mm	0,100	0,100	0,250	0,250	0,250
Volume of the measuring chamber		approx. cm ³	12	36	100	330	1200
Housing finish			enamelled red RAL 3013				
Weight with threaded ends ⁴⁾		approx. kg	2,2	2,5	4,2	17,3	–
with flanges PN 25		approx. kg	3,8	4,5	7,5	20,3	41,0
Pulse values of pulsers on VZOA:							
IN inductive according to DIN 19234		l/pulse	0,01	0,01	0,1	0,1	1
RV Reed		l/pulse	0,1	1	1	1	10
RV Reed		l/pulse	1	–	–	10	100
Pulse values of pulsers on VZEA:							
INA inductive according to DIN 19234 ⁵⁾		approx. l/pulse	0,0006	0,00185	0,005	0,017	0,060
Pulse frequency IN	at Q _{max}	Hz	16,667	41,667	8,333	25,000	8,333
	at Q _{min}	Hz	0,278	0,833	0,208	0,625	0,208
Pulse frequency INA	at Q _{max}	Hz	277,778	225,225	166,667	147,059	138,889
	at Q _{min}	Hz	4,630	4,505	4,167	3,676	3,472

Technical data for VZOA with PTB certification: 5.232 / 04.37 Class 1

Type		VZOA 15	VZOA 20	VZOA 25	VZOA 40	VZOA 50
Temperature max.	°C	130				
Maximum flow rate	Q _{max} ³⁾ l/h	400	1000	2000	6000	20000
Nominal flow rate	Q_n³⁾ l/h	400	1000	2000	6000	20000
Minimal flow rate	Q _{min} l/h	40	100	200	600	2000
Accuracy		1				
Max. permissible error	± % of actual value	0,5				

Technical data for VZOA with approval / EC custody transfer: D 04 / 5.232.14

Type		VZOA 15	VZOA 20	VZOA 25	VZOA 40	VZOA 50
Temperature max.	°C	50				
Maximum flow rate	Q _{max} ³⁾ l/h	400	1000	2000	6000	20000
Nominal flow rate	Q_n³⁾ l/h	400	1000	2000	6000	20000
Minimal flow rate	Q _{min} l/h	40	100	200	600	2000
Accuracy		0,5				
Max. permissible error	± % of actual value	0,3				

Two items are required when ordering: the VZOA counter and EU custody transfer, Article No. 96026.

- 1) Manufacturer's specification, valid for the reference condition as specified under meter data (annex).
- 3) For burners and engines or motors, the meter must basically be selected for permanent flow. For higher viscosity, or if the meter is installed on the suction side, the pressure drop and any reduction in the measuring range must also be considered; see Chapters 5 and 8.
- 4) Weight without couplings.
- 5) The precise pulse value can be taken from the meter; it is only known after the calibration. The next device must have an adjustable input.

Electronic Display VZEA

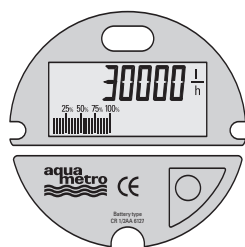

66017.4a

Display values:

- total volume, resettable volume, flow rate
- In the service level, service hours and other information can be read out

Display:

- 8-character LCD with identification of the parameter, height of numbers: 8 mm, flow rate (meter load) using bar diagram

Temperature:

- ambient temperature -10 ... +70 °C, storage temperature -20 ... +80 °C

Safety:

- CE, vibration and shock test to DIN IEC 68

Supply:

- usual commercial lithium battery, type CR 1/2AA or CR2

Data reception:

- by non-volatile memory (EEPROM)

Change of battery:

- after 5 years, based on a battery lifetime of 6 years with a maximum of 10 hours' digital display of the flow rate

Protection:

- IP54 (IEC 144) against splash water and dust

Pressure drop curves

in chapter 5

Dimensions in mm, VZEA

Meter	Length	Width	Height of meters VZEA	
			VZEA ... 130 °C and 180 °C	
				-INA
	L	W	H	H
VZEA 15	165	105	185	185
VZEA 20	165	105	194	194
VZEA 25	190	130	221	221
VZEA 40	300	210	273	273
VZEA 50	350	280	329	329

Dimensions in mm, VZOA

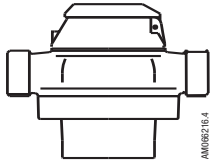
	Meter	Length	Width	Height of meters VZOA							
				VZOA ... 130 °C			VZOA ... 180 °C				
				L	W	H	-RV	-IN	H	-RV	-IN
							H	H		H	H
VZOA 15	165	105	147	171	185	147	171	225			
VZOA 20	165	105	156	180	194	156	180	234			
VZOA 25	190	130	183	207	221	183	207	261			
VZOA 40	300	210	235	259	273	235	259	313			
VZOA 50	350	280	291	315	329	291	315	369			

Detailed dimensional drawings in chapter 5

RV Pulsers

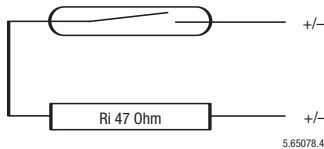

This pulser is integrated into the roller counter and is thus especially appropriate for remote totalisation. For other applications the use of the inductive pulser IN is preferable.

- | | |
|----------------------|---|
| Switching element: | • Reed switch with dry contact (inert gas) |
| Switching voltage: | • max. 48 V AC/DC |
| Switching current: | • max. 50 mA (Ri = 47 Ohm/0,5 W) |
| Static current: | • Open Contact |
| Switching power: | • max. 2 W |
| ON-time: | • 50% ± 10 % |
| Temperature: | • Ambient -10 ... +70 °C |
| Protection: | • IP 65 (IEC 144) against water-jets and dust |
| Connection: | • Cast-in cable, length 3 m |
| Cable cross section: | • 2 × 0,14 mm ² |

IN/INA Pulsers

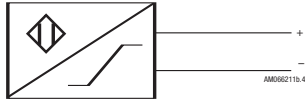

Pulser for industrial applications. Supplied with plug-in pulser sensor.

- | | |
|--------------------|---|
| Switching element: | • Slot initiator according to DIN 19234 |
| Switching voltage: | • 5 ... 15 V DC |
| Residual ripple: | • max. 5 % |
| Switching current: | • > 3 mA bei 8 V DC / 1 kOhm |
| Static current: | • < 1 mA bei 8 V DC / 1 kOhm |
| ON-time: | • 50% ± 10 % |
| Temperature: | • Ambient -10 ... +70 °C |
| Protection: | • IP 65 (IEC 144) against water-jets and dust |
| Connection: | • Pulser supplied with special plug. Required cable min. 2 x 0.35 mm ² and 4...6 mm external diameter or optional pn 80019 with mounted cable. |
| Option: | • Cable mounted, 2 x 0.5 mm ² , PVC black, length 3 m (pn 80019) |

Type designation key

VZOA 25 FL 130/25-IN

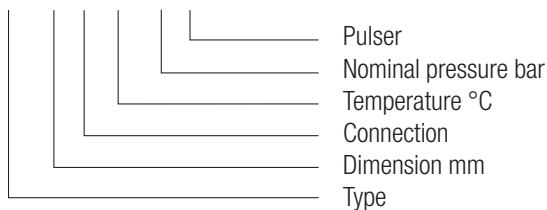

Information required to process orders

When the order is placed, information is required on the plant operating conditions (as stated at the beginning of this chapter). Please note that for custody transfer (commercial transactions) VZOA type meters have to be used.

Example for differential measurement:

Application: Differential measurement diesel, supply 200 l/h, return 120. ... 190 l/h
 2 Pieces Order No. 92290 CONTOIL® fuel oil meter, type VZOA 20 RC 130/16
 2 Pieces Order No. 96112 Modification for differential measurement

Example for custody transfer:

Application: Custody transfer in Germany, heating fuel extra light, flow rate 200...400 l/h, temperature approximately 20 °C
 1 Piece Order No. 92290 CONTOIL®, fuel oil meter, type VZOA 20 RC 130/16
 1 Piece Order No. 96026 Modification with EC custody transfer

Example for meter without modification:

Application: Measurement of Diesel fuel on testing facility, flow rate 200...400 l/h, temperature 20...50 °C
 1 Piece Order No. 92333 CONTOIL®, fuel oil meter, type VZEA 20 RC 130/16

Ordering specifications VZEA (with electronic display)

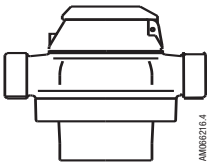
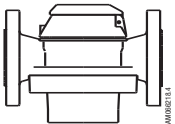
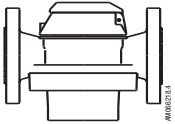
Threaded ends 	Type	Order No.	Type	Order No.
	VZEA 15 RC 130/16	92331	VZEA 25 RC 130/16	92335
	VZEA 15 RC 130/16-INA ¹⁾	92332	VZEA 25 RC 130/16-INA ¹⁾	92336
	VZEA 20 RC 130/16	92333	VZEA 40 RC 130/16	92337
	VZEA 20 RC 130/16-INA ¹⁾	92334	VZEA 40 RC 130/16-INA ¹⁾	92338
Flanges 130 °C / PN 25 	VZEA 15 FL 130/25	92339	VZEA 40 FL 130/25	92353
	VZEA 15 FL 130/25-INA ¹⁾	92340	VZEA 40 FL 130/25-INA ¹⁾	92354
	VZEA 20 FL 130/25	92343	VZEA 50 FL 130/25	92361
	VZEA 20 FL 130/25-INA ¹⁾	92344	VZEA 50 FL 130/25-INA ¹⁾	92362
	VZEA 25 FL 130/25	92347		
	VZEA 25 FL 130/25-INA ¹⁾	92350		
Flanges 180 °C / PN 25 	VZEA 15 FL 180/25	92341	VZEA 40 FL 180/25	92355
	VZEA 15 FL 180/25-INA ¹⁾	92342	VZEA 40 FL 180/25-INA ¹⁾	92360
	VZEA 20 FL 180/25	92345	VZEA 50 FL 180/25	92363
	VZEA 20 FL 180/25-INA ¹⁾	92346	VZEA 50 FL 180/25-INA ¹⁾	92365
	VZEA 25 FL 180/25	92351		
	VZEA 25 FL 180/25-INA ¹⁾	92352		

Modification VZEA and Option / Accessory

Modification	For differential measurement (for VZEA or VZOA)	96112
Option / Accessory ¹⁾	Mounted cable IN/INA ¹⁾	80019

Ordering specifications VZOA (Volume display on roller register)

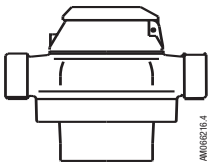
Threaded ends 	Type	Order No.	Type	Order No.
		VZOA 15 RC 130/16	92286	VZOA 25 RC 130/16
	VZOA 15 RC 130/16-RV 0,1	92287	VZOA 25 RC 130/16-RV 1	92294
	VZOA 15 RC 130/16-RV 1	92288	VZOA 25 RC 130/16-IN 0,1 ¹⁾	92295
	VZOA 15 RC 130/16-IN 0,01 ¹⁾	92289		
	VZOA 20 RC 130/16	92290	VZOA 40 RC 130/16	92296
	VZOA 20 RC 130/16-RV 1	92291	VZOA 40 RC 130/16-RV 1	92297
	VZOA 20 RC 130/16-IN 0,01 ¹⁾	92292	VZOA 40 RC 130/16-IN 0,1 ¹⁾	92298

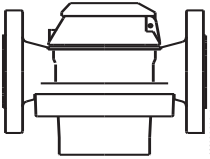
Flanges 130° C / PN 25 	Type	Order No.	Type	Order No.
		VZOA 15 FL 130/25	92299	VZOA 40 FL 130/25
	VZOA 15 FL 130/25-RV 0,1	92300	VZOA 40 FL 130/25-RV 1	92310
	VZOA 15 FL 130/25-RV 1	92301	VZOA 40 FL 130/25-IN 0,1 ¹⁾	92311
	VZOA 15 FL 130/25-IN 0,01 ¹⁾	92302		
	VZOA 20 FL 130/25	92303	VZOA 50 FL 130/25	92312
	VZOA 20 FL 130/25-RV 1	92304	VZOA 50 FL 130/25-RV 10	92313
	VZOA 20 FL 130/25-IN 0,01 ¹⁾	92305	VZOA 50 FL 130/25-IN 1 ¹⁾	92314
	VZOA 25 FL 130/25	92306		
	VZOA 25 FL 130/25-RV 1	92307		
	VZOA 25 FL 130/25-IN 0,1 ¹⁾	92308		

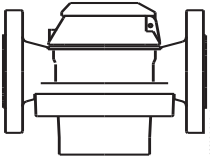

Flanges 180° C / PN 25 	Type	Order No.	Type	Order No.
		VZOA 15 FL 180/25	92315	VZOA 40 FL 180/25
	VZOA 15 FL 180/25-RV 0,1	92316	VZOA 40 FL 180/25-RV 1	92326
	VZOA 15 FL 180/25-RV 1	92317	VZOA 40 FL 180/25-IN 0,1 ¹⁾	92327
	VZOA 15 FL 180/25-IN 0,01 ¹⁾	92318		
	VZOA 20 FL 180/25	92319	VZOA 50 FL 180/25	92328
	VZOA 20 FL 180/25-RV 1	92320	VZOA 50 FL 180/25-RV 10	92329
	VZOA 20 FL 180/25-IN 0,01 ¹⁾	92321	VZOA 50 FL 180/25-IN 1 ¹⁾	92330
	VZOA 25 FL 180/25	92322		
	VZOA 25 FL 180/25-RV 1	92323		
	VZOA 25 FL 180/25-IN 0,1 ¹⁾	92324		

Modification VZOA and Option / Accessory

Modification	For differential measurement	96112
	For type approval GL German. Lloyd	96295
	For EC custody transfer	
Option / Accessory	Mounted cable IN/INA ¹⁾	80019

Ancillaries

Ordering specifications for ancillaries

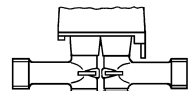
	Type	Description	Order No.
Threaded connections 	VSR 1/2" VSR 3/4" x 1/2" VSR 3/4" VSR 1" VSR 1 1/2"	for DN 15 for DN 20 for DN 20 for DN 25 for DN 40	81160 81163 81166 81169 81181
Threaded connections kit 	PS-Kit VZO 4	1/8" – 8	81583
Mounting kit 	PS-Kit VZO 8 VSR 3/8"	Mounting Kit Threaded connections to suit PS-Kit VZO 8	81130 81156

Order specifications for supplementary equipment

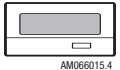
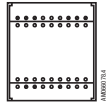
	Type	Description	Order No.
Remote totaliser 	Pulse counter	Pulse counter, with or without zeroing, adjustable	93374
Separating relays 	Separating relays Ex Separating relays Ex	with relay output, max. 10 Hz with electronic output, max. 5 kHz	81705 80013

Order specifications for supplementary equipment with mounting kits

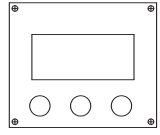
	Type	Description	Order No.
Transducers 	Flow calculator	freely programmable, with analogue output 4...20 mA, indication of flow rate, limit values	92439
	Differential flow calculator	freely programmable, with analogue output 4...20 mA, indication of flow rate, limit values. Both inputs can be read out individually.	92440
	Frequency current converter	freely programmable.	92439
Mounting kit	Kit	for wall mounting or on rail DIN 35 mm	on request

Meter data (annex)

Function

CONTOIL® flow meters work on the volumetric principle of rotary piston meters (positive displacement meters). The main features of this measuring principle are large measuring ranges, high accuracy, suitability for high viscosities and independence from power supply; flow disturbances do not influence proper operation.



Construction

Rotary piston, guide roller and driver are the only moving parts in contact with the liquid. As the hydraulic part is completely separated from the roller counter, the movement of the rotary piston is transmitted by a magnetic coupling through the sealing plate.

VZO 4 and VZO 8

Inlet and outlet connections are to be made perpendicular to the bottom plate of the meter. OEM versions with connections located at the sides.



VZE/VZO/VZEA and VZOA 15 ... 50

These meters are equipped with counters, which are rotatable through almost 360° for easy reading (exception: versions with Reed pulser RV).



Accuracy Limits: Reference Conditions

Accuracy limits according to technical data of meter in % of actual value for the whole measuring range.

Reference conditions

Liquid: Calibration oil similar to heating fuel extra light, density at 20° C = 814 kg/m³
 Viscosity = 5,0 mm²/s selon DIN 51757 / ISO 3104 (corresponds to 4,1 mPa.s)
 Temperature: 18 ... 25° C
 Horizontal mounting, readings on register.
 CONTOIL® Oil meters are never to be tested with water, otherwise they would get damaged.

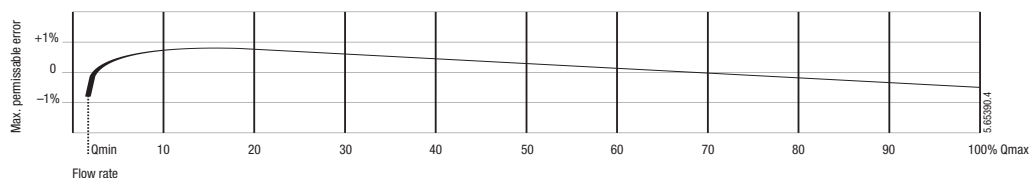

Pressure drop curves

Viscosity information

Kinematic viscosity
Dynamic viscosity

Stokes, Centi-Stokes, mm²/s
Pascal seconds, millipascal seconds
Poise, Centipoise (outmoded)

St, cSt, mm²/s
Pas, mPa.s
P, cP

Conversion

cSt × density = mPa.s
Engler degrees °E to mPa.s: only using comparative table
Saybold units to mPa.s: only using comparative table
Redwood units to mPa.s: only using comparative table

Rule of thumb

1 cSt → 1 mm²/s → 1 mPa.s

DN 4

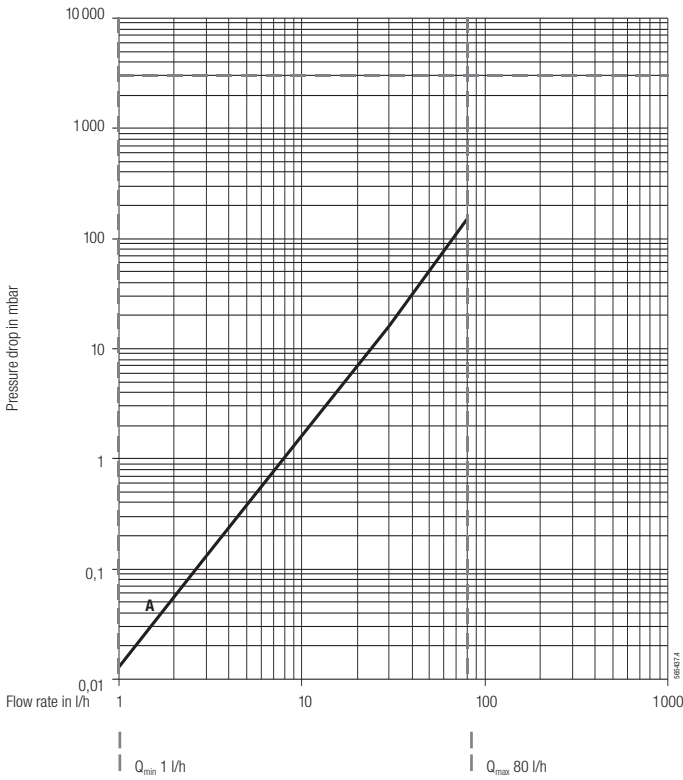

DN 8

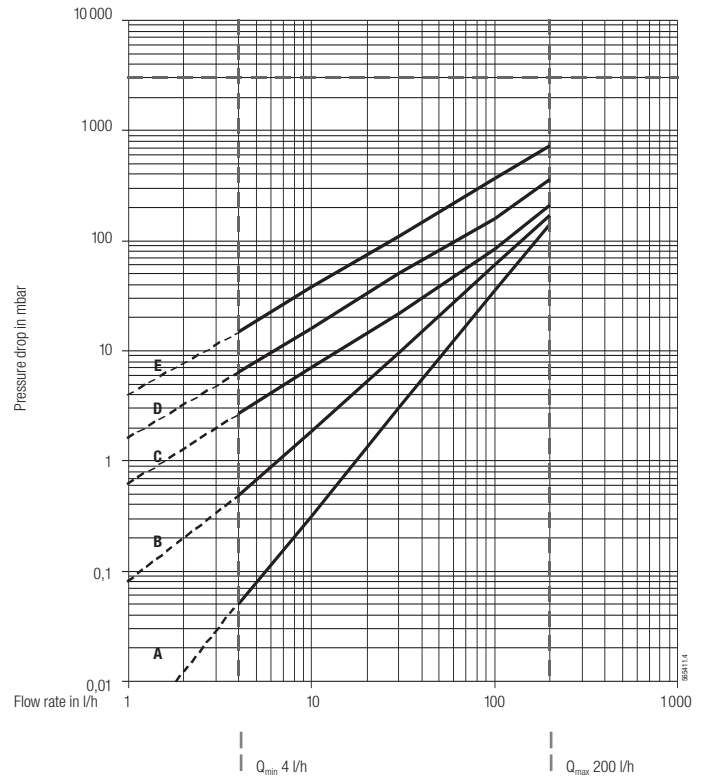

Viscosity curves:

A = 5 mPa.s
B = 50 mPa.s

C = 100 mPa.s
D = 200 mPa.s

E = 500 mPa.s

For a pressure drop of more than 1 bar, you are advised to use the next higher nominal meter width.
Maximum permissible pressure drop = 3 bar

DN 15

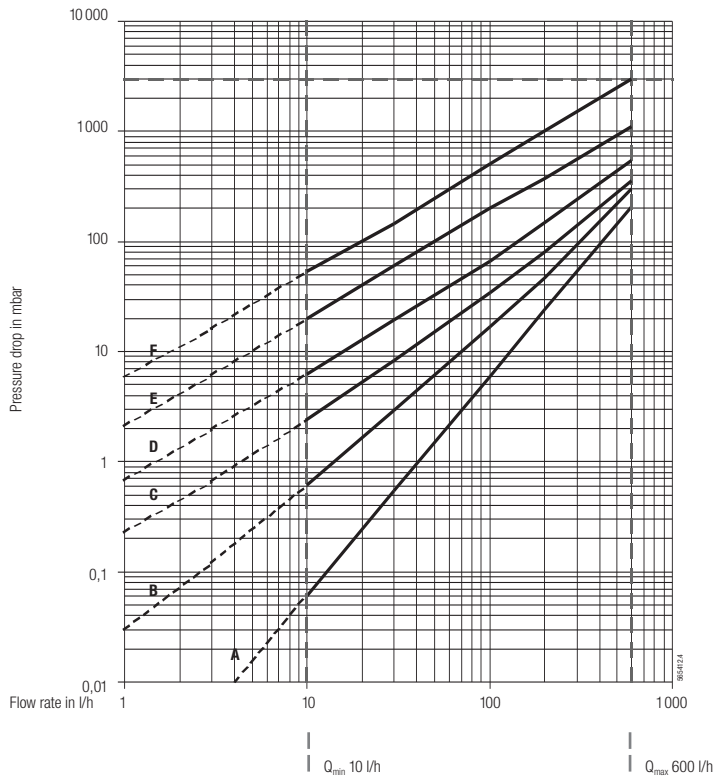

DN 20

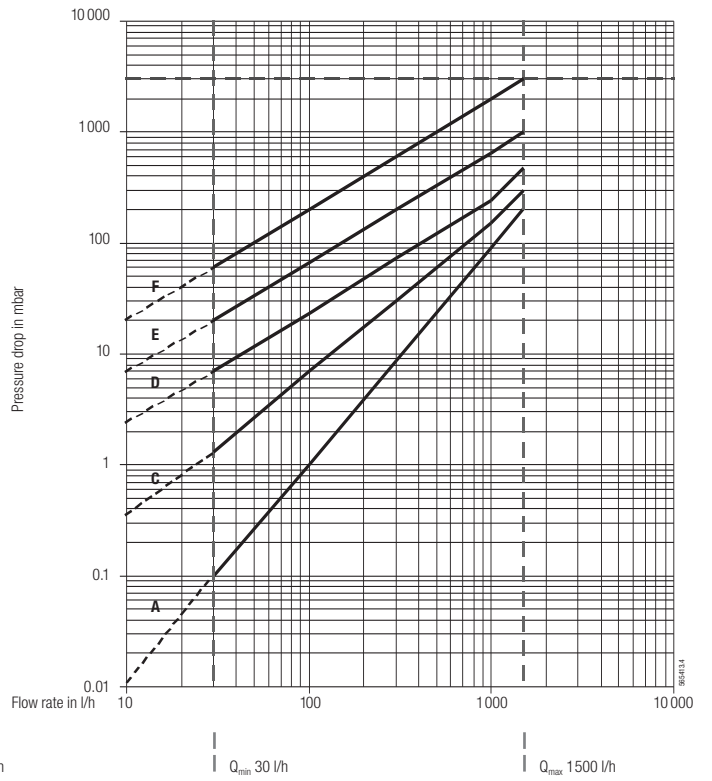

DN 25

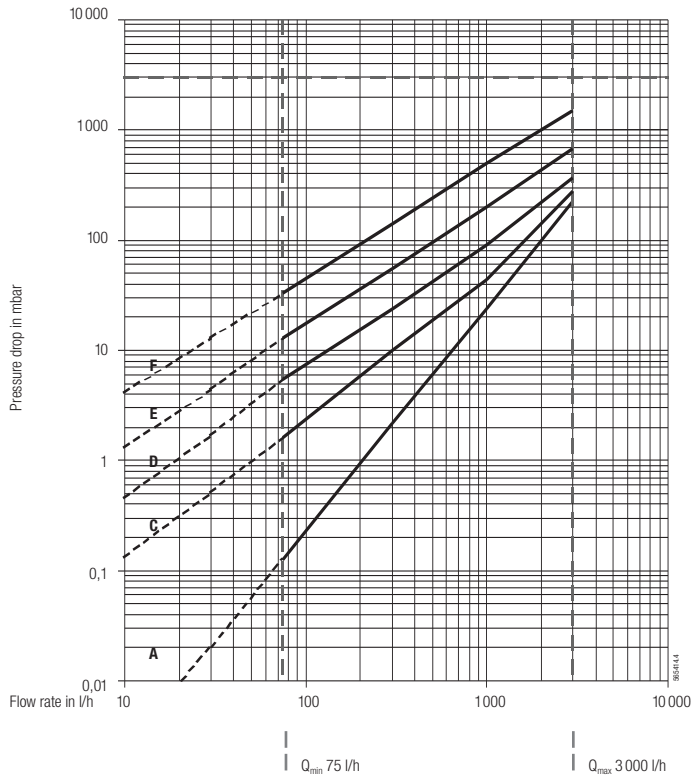

DN 40

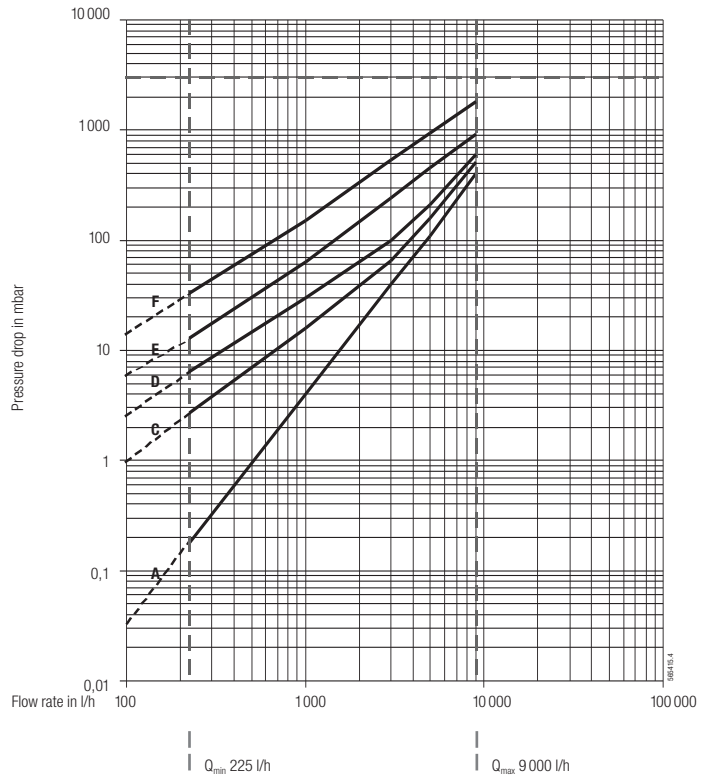

Viscosity curves:

A = 5 mPa.s
B = 25 mPa.s

C = 50 mPa.s
D = 100 mPa.s

E = 200 mPa.s
F = 500 mPa.s

For a pressure drop of more than 1 bar, you are advised to use the next higher nominal meter width.
Maximum permissible pressure drop = 3 bar

DN 50

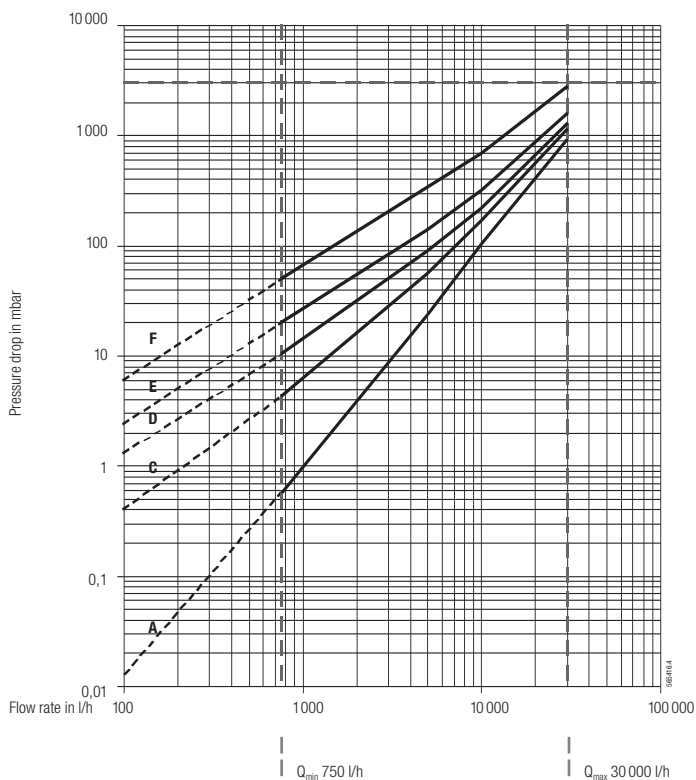

Materials		Meter Size DN						
Part	Material	4	8	15	20	25	40	50
Housing / Measuring unit	Brass	●	●					
Housing with threaded ends	Cast brass			●	●	●		
	Spheroidal graphite iron GGG						●	
Housing with flanges	Spheroidal graphite iron GGG			●	●	●	●	●
Measuring chamber - PN 16 / 25	Cast brass			●	●	●	●	
	Red brass							●
- PN 40	Stainless steel			●	●	●	●	●
Seals	NBR Butadiene-Acrylnitril	●						
	FPM Fluorelastomer	S	●	●	●	●	●	●
Rotary piston	Aluminium anodized	●	●	●	●	●	●	●
Ancillaries	Plastic			●	●	●	●	●
Cover of meter	Plastic	●	●					

S = Special versions

Dimensions in mm

VZ0/VZ0A 4 and 8

DN 4

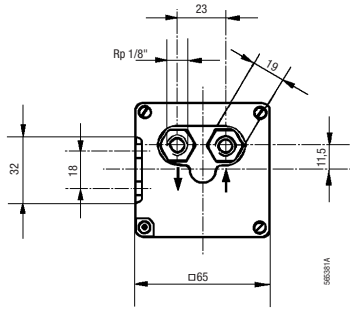

DN 8

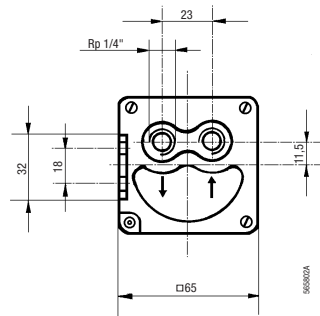

without pulser

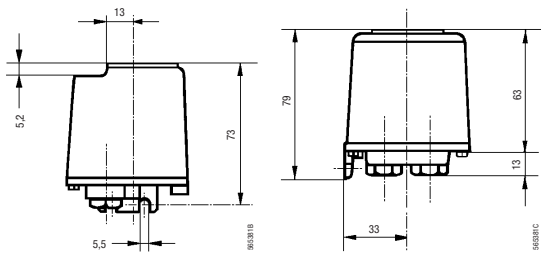

without pulser

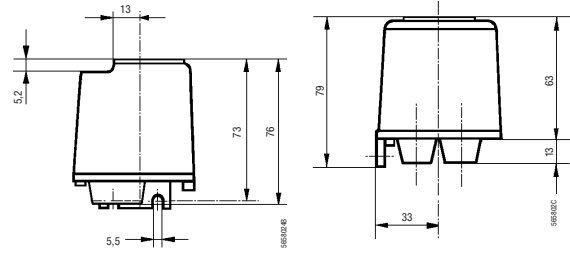

with pulser

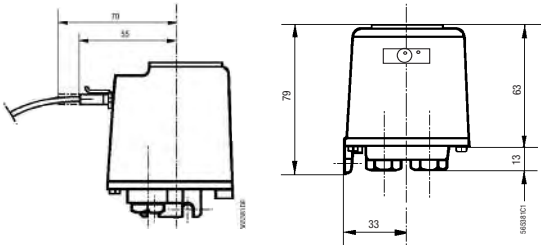

with pulser

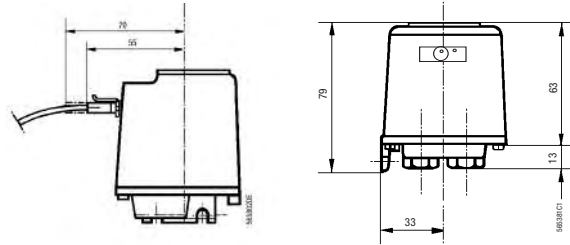

Dimensions in mm

VZE / VZO / VZEA / VZOA Measuring units

DN 15, 20, 25: with threaded ends

DN 40: with threaded ends

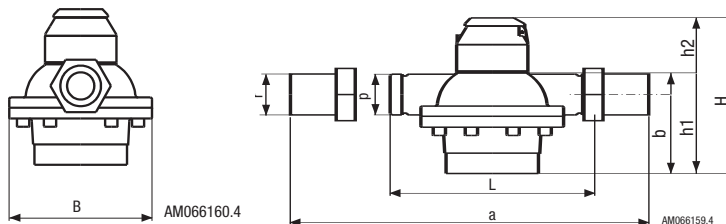
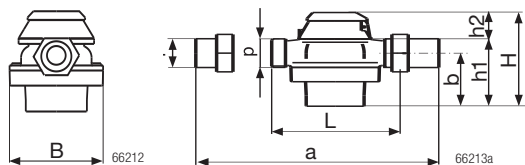

DN 15, 20, 25: with flanges (DIN 2501/SN 21843)

DN 40, 50: with flanges (DIN 2501/SN 21843)

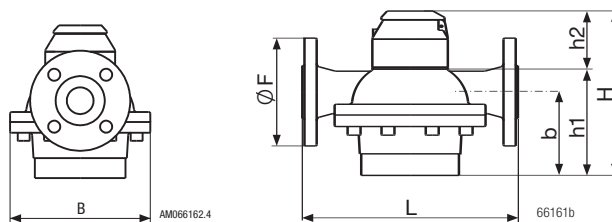
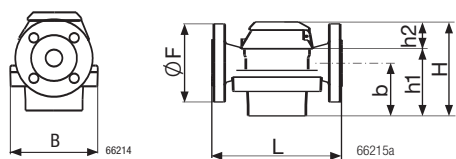

Nominal width	L	B	a	Ø F	b	h1	p	r
DN 15	165	105	260	95	45	65	G 3/4"	G 1/2"
DN 20	165	105	260	105	54	74	G 1"	G 3/4"
DN 25	190	130	305	115	77	101	G 1 1/4"	G 1"
DN 40	300	210	440	150	116	153	G 2"	G 1 1/2"
DN 50	350	280	—	165	166	209	—	—

VZE / VZEA Ancillaries

Electronic display

Electronic display
and INA pulser

Electronic display

Electronic display
and INA pulser

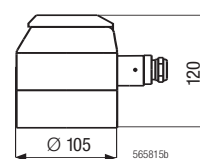
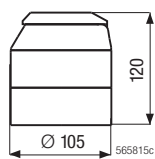
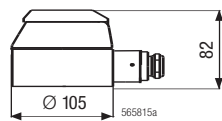
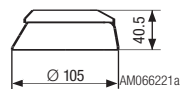

Tmax 70 °C

T max 130 °C or 180 °C

Dimensions in mm

VZO / VZOA Ancillaries

VZO 15, 20, 25

Roller register

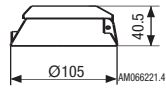

Roller register with RV pulser

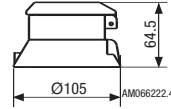

Roller register and IN pulser

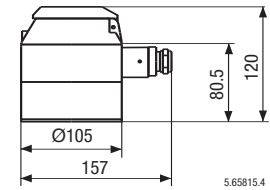

Tmax. 130° C

VZO 40, 50
VZOA 15 ... 50

Roller register

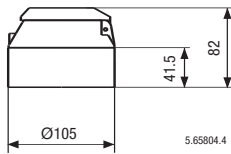

Roller register with RV pulser

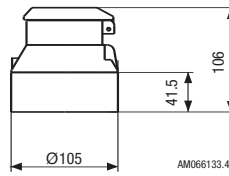

Roller register and IN pulser

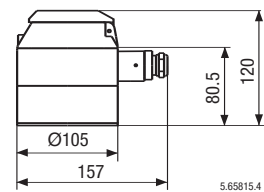

Tmax. 130° C

VZO 15 ... 50
VZOA 15 ... 50

Roller register

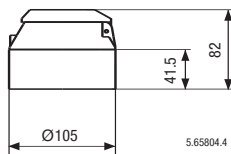

Roller register with RV pulser

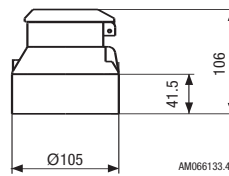

Roller register and IN pulser

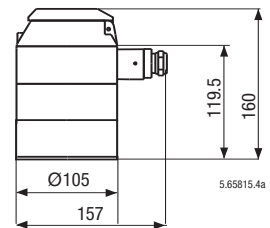

Tmax. 180° C

Electronic display / dial

VZE / VZEA

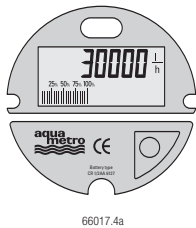

VZO / VZOA 15

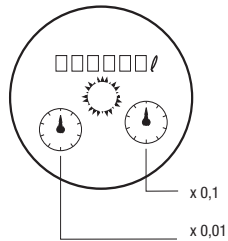

VZO / VZOA 20, 25, 40

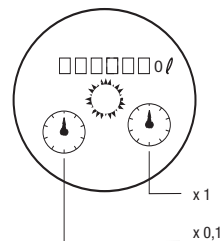

VZO / VZOA 50

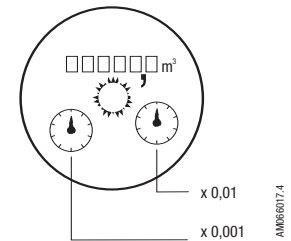

Selection of the optimal meter

Type	VZE 15-50	VZO 4-8	VZO 15-50	VZEA 15-50	VZOA 4-8	VZOA 15-50
Application						
Direct consumption measurement	●	●	●	●	●	●
Differential measurement	–	–	–	●	–	●
Measuring points requiring approval	–	–	–	–	●	●
Requiring custody transfer for commercial transactions	–	–	–	–	●	●
Most frequent areas of use						
Domestic / industrial burner	light/medium oil	●	●	●	●	●
	heavy oil	3)	–	3)	1)	1)
Diesel engines	diesel oil	●	●	●	●	●
Ship motors	heavy oil	●	–	●	–	●
Petrol engines		2)			–	
Common applications						
InHeating systems	●	●	●			
AufShips			●			●
ADiesel locomotives		●	●			●
ATrucks/coaches/construction machinery		●	●			●
Medium						
Heating fuel light	●	●	●	●	●	●
Heating fuel medium	●	●	●	●		●
Heating fuel heavy	3)	–	3)	1)	–	1)
Diesel	●	●	●	●	●	●
Petrol		2)			–	
Display of flow data						
Total volume	●	●	●	●	●	●
Resettable volume	●	–	–	●	–	–
Actual flow rate	●	–	–	●	–	–
Method of display						
Electronic display LCD	●	–	–	●	–	–
Total volume display on roller register	–	●	●	–	●	●
Accuracy limit						
± 1% if actual value	●	●	●	–	DN 4	–
± 0,5% of actual value or smaller	–	–	–	●	DN 8	●
PTB approval Class 1	–	–	–	–	●	●
EC approval/custody transfer Class 1	–	–	–	–	DN 4	–
EC approval/custody transfer Class 0.5	–	–	–	–	DN 8	●
Pulsar (Option)						
Inductive, with high resolution	●	–	–	●	–	–
Inductive, with decadic pulse value	–	–	●	–	–	●
Reed pulse for remote totalisation	–	●	●	–	●	●
Information in chapter	1	2	2	3	2	3

- applicable
- not applicable

Messstoffe und geeignete Zählernennweite	DN 4	DN 8	DN 15	DN 20	DN 25	DN 40	DN 50
Heating fuel light	●	●	●	●	●	●	●
Heating fuel medium	●	●	●	●	●	●	●
Heating fuel heavy	–	–	3)	●	●	●	●
Diesel	●	●	●	●	●	●	●
Petrol	2)	2)					

- 1) Only in accordance with the maximum mesh size of the dirt trap as per technical data.
- 2) The device is to be set according to the operating conditions (other measured values!).
- 3) DN 15 only when the plant has a dirt trap with a max. 0.1 mm mesh width.

Application note

For viscosity's higher than 5mPa.s or for installations on the suction side, consider pressure drop and possible limitation of flow range (see chapter 5 and 8).

Fluid fuel oil

Characteristics of different fuels

Fuel		extra light	light	medium	heavy	Bunker C
Density at 15° C	min.	0,82	0,82	0,82	0,82	0,90
	max.	0,86	0,95	0,96	0,99	1,01
Volume at average density		1,19	1,12	1,12	1,11	1,08
Viscosity at	20° C	8	14	50	420	4200
	40° C	3	5	16	60	380
	100° C	—	—	3	10	35
Energy value		11,8	10,6	11,4	11,2	11,0

Data for burner and engine power

Burner

Burner			Fuel oil meter		
Power up to kW	Flow rate heating fuel EL		Flow rate		Dimension DN
	kg/h	l/h	Qmin...Qn l/h		
500	42	50	1 ...	50	4
1 300	113	135	4 ...	135	8
4 000	336	400	10 ...	400	15
10 000	840	1 000	30 ...	1 000	20
20 000	1 680	2 000	75 ...	2 000	25
60 000	5 040	6 000	225 ...	6 000	40
200 000	16 800	20 000	750 ...	20 000	50

Formula for consumption in litres/hour:

Example:

$$\frac{\text{Burner power in kW}}{\text{Energy value of fuel in kWh/kg} \times \text{density in kg/dm}^3} = \frac{600 \text{ kW}}{11,8 \text{ kWh/kg} \times 0,82 \text{ kg/dm}^3} = 62 \text{ l/h}$$

Engines

Engine			Fuel oil meter ¹⁾		
Power up to ... approx. HP	approx. kW	Diesel fuel consumption l/h	Flow rate		Dimension DN
			Qmin...Qn l/h		
250	184	50	1 ...	50	4
680	500	135	4 ...	135	8
2 000	1 470	400	10 ...	400	15
5 000	3 680	1 000	30 ...	1 000	20
10 000	7 360	2 000	75 ...	2 000	25
30 000	22 000	6 000	225 ...	6 000	40
100 000	73 600	20 000	750 ...	20 000	50

1) For differential measurement the flow meter has to be selected according to the pump flow rate and the flow in the return pipe. Consider chapter 9!

Formula:

$$1 \text{ HP} = 0,736 \text{ kW} \quad 1 \text{ kg Diesel at } 0,84 \text{ kg/dm}^3 = 1,19 \text{ l}$$

$$1 \text{ kW} = 1,36 \text{ HP}$$

Rule of thumb:

$$\text{approx. } 190 \text{ g/kWh correspond to } 0,226 \text{ l/kWh}$$

$$\text{approx. } 140 \text{ g/HP and hour correspond to } 0,167 \text{ l/HP/h}$$

How to obtain an optional measurement

Planning

Flow meters are precision measuring instruments. They achieve optimal results if

- a few important rules are observed during plant design,
- mounting and commissioning are carried out with care,
- the meters are used for their defined purpose only.

Layout of Pipework

- The quantities consumed by all the users must be registered by the meter.
- Rotary piston meters can be mounted without straight stabilisation pipes (after bends, T-pieces or fittings) in horizontal, vertical or inclined position. Do not mount the meter with the head pointing downwards.
- The layout of piping must ensure that the meter is at all times filled with liquid and that no inclusion of air or gas may occur.
- Easy access for reading the meter and controlling the ancillary equipment is essential.

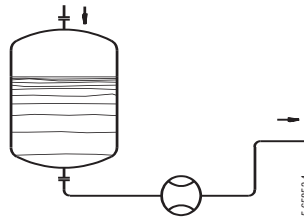
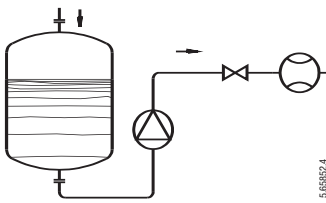

Selection of the Meter and Ancillaries

To be considered when selecting the meter:

- Operating temperature
- Viscosity of the medium
- Operating pressure
- Flow rate
- Resistance of the material against liquid to be metered and working conditions

The technical data are valid for the following reference condition: EL heating fuel / diesel at 20° C. For higher viscosity's or if the meter is mounted on the suction side, it is necessary to determine the pressure drop and the flow rate that can still be attained by using the pressure loss curves (Chapter 5). If the pressure drop is more than 1 bar, you are advised to use the next higher nominal meter width. Maximum permissible pressure drop = 3 bar.

Example 1:

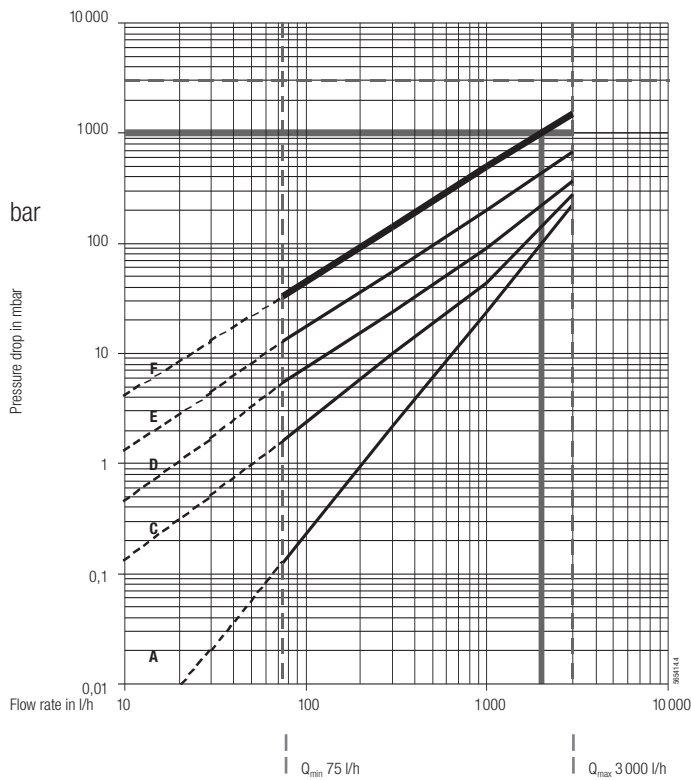

Medium Mineral oil, Viscosity 450 mPa.s
Mounting VZE 25 on pressure side

1. Viscosity line
E = 200 mPa.s
F = 500 mPa.s
2. Supposition for max. permissible pressure drop = 1
3. From the intersection of line F and pressure drop 1 bar downwards, the possible flow rate of 2000 l/h is obtained.

Example 2:

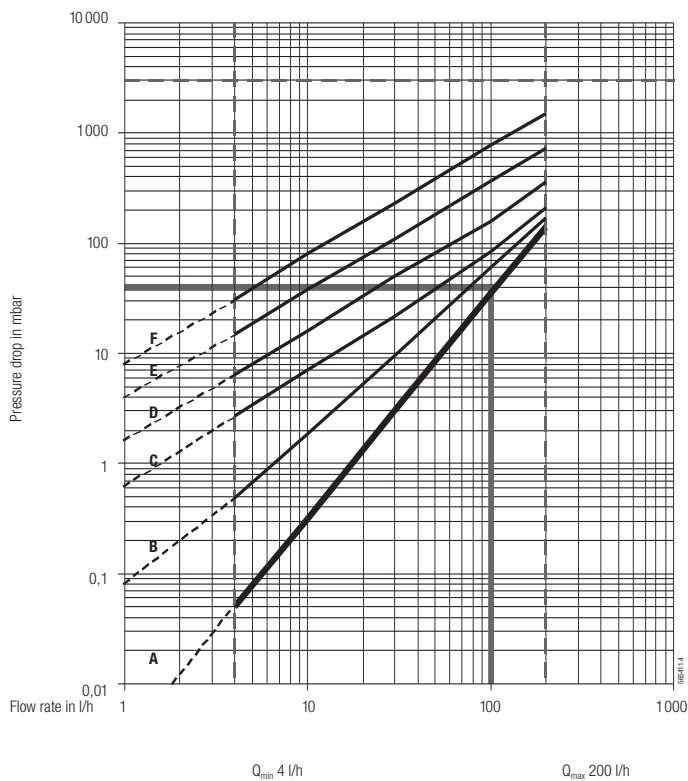

Medium Heating fuel extra light
Mounting VZO 8 on suction side

1. Viscosity line
A = 5 mPa.s
B = 25 mPa.s
C = 50 mPa.s
2. Supposition for max. permissible pressure drop = 40 mbar
3. From the intersection of line A and pressure drop 40 mbar downwards, the possible flow rate of 100 l/h is obtained.

Mounting on pressure side (burners)

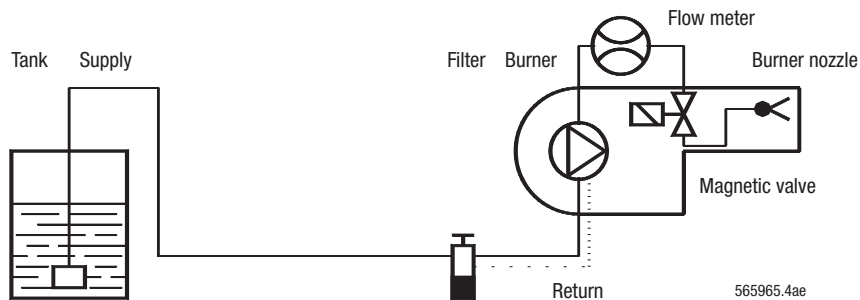

Mounting on Suction side (burners)

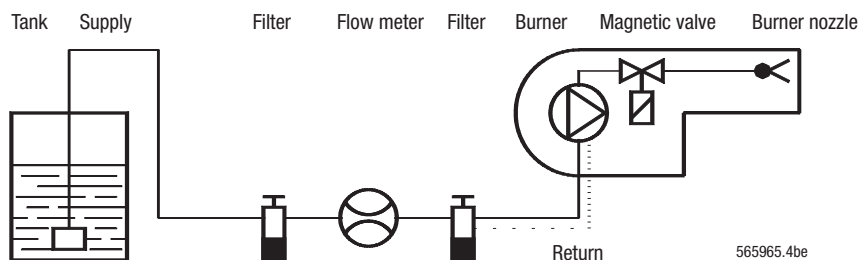

Impurities in plant or liquid

Should impurities occur in the plant or in the liquid, a strainer (dirt trap) has to be installed before the meter. The filter mounted in the meter inlet is only a safety filter and is too small to act as a strainer.

Maximum mesh width for strainers/dirt traps	Meter size	Meter type		
		VZE	VZO	VZEA / VZOA
<p>565948.4</p>	DN 4	—	0,080 mm	0,080 mm
	DN 8	—	0,100 mm	0,100 mm
	DN 15	0,250 mm	0,250 mm	0,100 mm
	DN 20	0,400 mm	0,400 mm	0,100 mm
	DN 25	0,400 mm	0,400 mm	0,250 mm
	DN 40	0,600 mm	0,600 mm	0,250 mm
	DN 50	0,600 mm	0,600 mm	0,250 mm

Shut-off Devices

In order to avoid backflows and drainings, shut-off devices have to be mounted after the meter. Backflows and drainings cause measuring errors and can damage the meter.

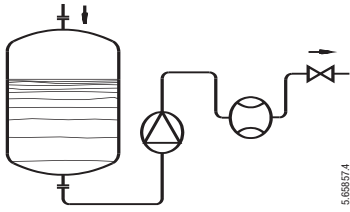

Filling/Dosing

For filling and dosing the valve has to be mounted between meter and discharge. The shorter the pipe section between meter and discharge, the higher the accuracy. Fast opening and shutting of the valve should be avoided (pressure hammer!).

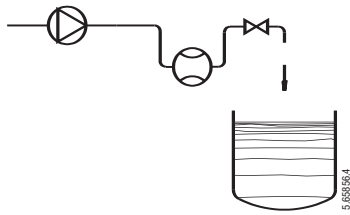

Remote Processing/Ancillaries

Any backflow must be avoided on meters equipped with pulsers for remote processing. If this cannot be achieved by appropriate plant design, a non-return valve should be fitted.

Electrical lines and installations

Electrical lines and installations are subject to statutory regulations which must be taken into account when planning the system. For installations in zones subject to explosion hazards, please consult an expert.

The following factors should be taken into account during plant design:

- ancillaries connected after the meter
- environmental disturbances
- maximum cable lengths with or without amplifier
- connection boxes, cable guides

Pulsers

Power supply

Our range of products includes passive pulsers for the remote processing of flow data. The pulser generates one pulse unit of volume and is to be supplied with power from the pulse processing device.



Power supply 5 ... 48 V AC/DC

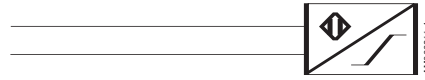

Power supply 5 ... 15 V DC

Selection of the appropriate pulser

The selection of the most appropriate pulser and pulse value depends on the application. As a rule, remote totalisation demands rather large pulse values, whereas analogue signals, dosing control or indication of actual flow tend to need small values. Battery supplied devices can only be used together with Reed pulsers.

Selection of the processing device

The pulse length depends on the flow rate. Continuous contact may occur at zero flow. The device connected must therefore be able to accept continuous load; otherwise, protective measures have to be taken. For remote totalisation, you are recommended to use an electronic pulse counter with a low power consumption and bounce filter.

Correct pulse processing

Interrupted flow may cause hydraulic oscillation of the liquid in certain plants (hydraulic vibration with minimal flow backward/forward). The pulses which can occur in such cases may be interpreted as forward flow by the connected device. Such faulty pulses do not affect the indication of the actual value since they can only occur at almost zero flow. However, if the pulser controls a counting device, hydraulic vibration must be avoided by an appropriate modification or layout of the plant.

Pulse values

Pulse values depend on type and nominal diameter of the meter. They are listed in the technical information of the meter concerned.

Pulse period

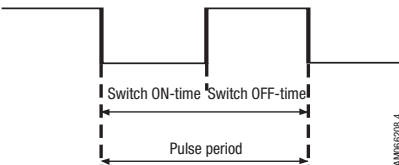

Pulse period as well as on- and off-times can be calculated with the following formula:

$$\text{Pulse period in s} = \frac{\text{pulse value in litres} \times 3600}{\text{flow Q in l/h}}$$

$$\text{On-time} = \frac{\text{pulse period in s} \times \text{on-time in \% of pulse period}}{100}$$

$$\text{Off-time} = \text{pulse period in s} - \text{on-time}$$

We recommend that this calculation is carried out for the min. and max. expected flow rates.

Application examples

Diesel engine

Direct consumption measurement

In place of the fuel feedback, an intermediate container with a heat exchanger is installed in the tank on the system side. The flow measurement is taken in the supply pipe to the intermediate tank. The load on the meter and the measuring result correspond precisely to the consumption.

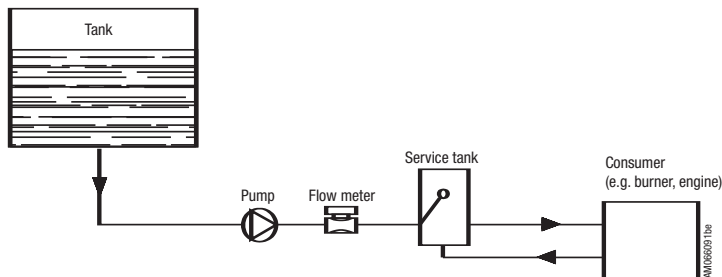

Differential measurement

For a differential measurement, the pipe routing is kept unchanged, with circulation back into the tank. A flowmeter is installed in both the pipes. The consumption is determined as the difference between the amount in the supply section and the amount in the return section. The meter loads therefore correspond to the supply and return flow rates.

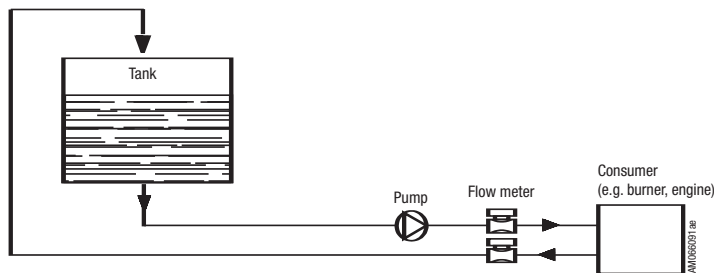

Reason to use meters with special pairing

Standard meters feature a large measuring range and a max. permissible error of $\pm 1\%$. This makes them unsuitable for differential measurements, as the following example shows:

Full load	Supply	400 l/h	Error $\pm 1\%$	= nominal $\pm 4,0$ l
	Return	150 l/h	Error $\pm 1\%$	= nominal $\pm 1,5$ l
	Consumed	250 l/h	Measuring error	nominal $\pm 5,5$ l
	Maximum measuring error	Consumed = $5,5 \times 100 : 250 = \pm 2,2\%$		
Min. load	Supply	400 l/h	Error $\pm 1\%$	= nominal $\pm 4,0$ l
	Return	360 l/h	Error $\pm 1\%$	= nominal $\pm 3,6$ l
	Consumed	40 l/h	Measuring error	nominal $\pm 7,6$ l
	Maximum measuring error	Consumed = $7,6 \times 100 : 40 = \pm 19\%$		

For an optimal result, special meters are therefore used for differential measurements. These are precisely co-ordinated to the operating conditions and are calibrated in pairs. This means that the measurement variance can be significantly reduced (for example: supply, at constant flow, to $\pm 0.1\%$; return, with slightly variable flow, to $\pm 0.3\%$).

Loads on meters

Example: Engine power 500 hp, vehicle with electric pump

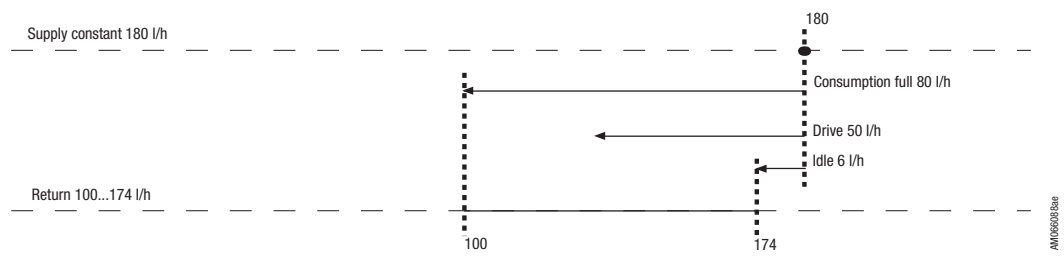

Effective loads on meters

Supply	constant 180 l/h
Return	100 ... 174 l/h

Example: Engine power 500 hp, vehicle with RPM dependent pump 1:4

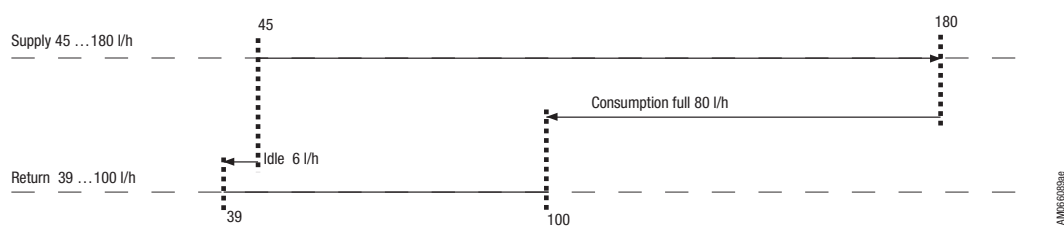

Effective loads on meters

Supply	45 ... 180 l/h
Return	39 ... 100 l/h

Consumption measurement on board ships

On board ships, care is usually taken to ensure that the engine can still be operated at full power even if the filter is heavily contaminated or if the meter is damaged. When switching over to the bypass, attention may be drawn to the necessary maintenance via an alarm output, and the engine can be temporarily operated without measuring the consumption.

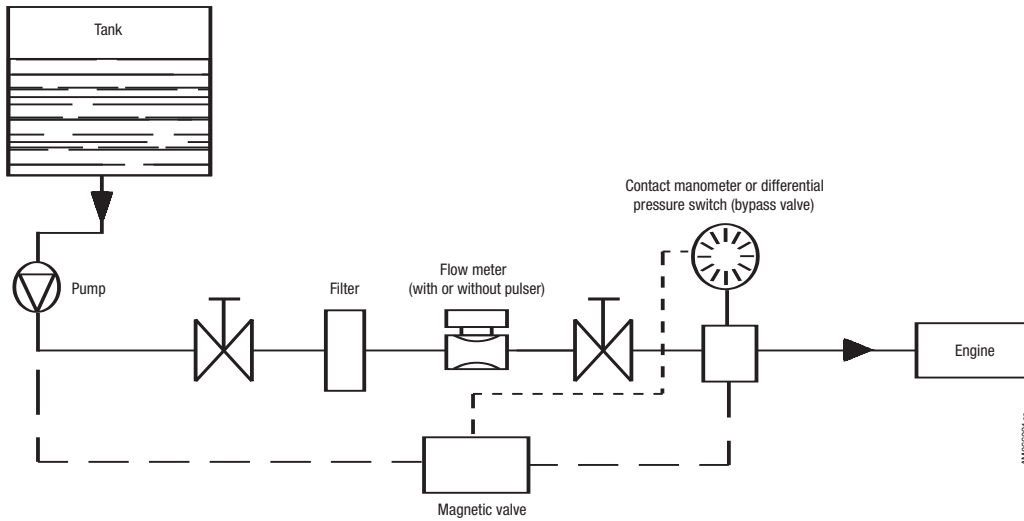

The magnetic valve opens as soon as the pressure drops below a defined level.

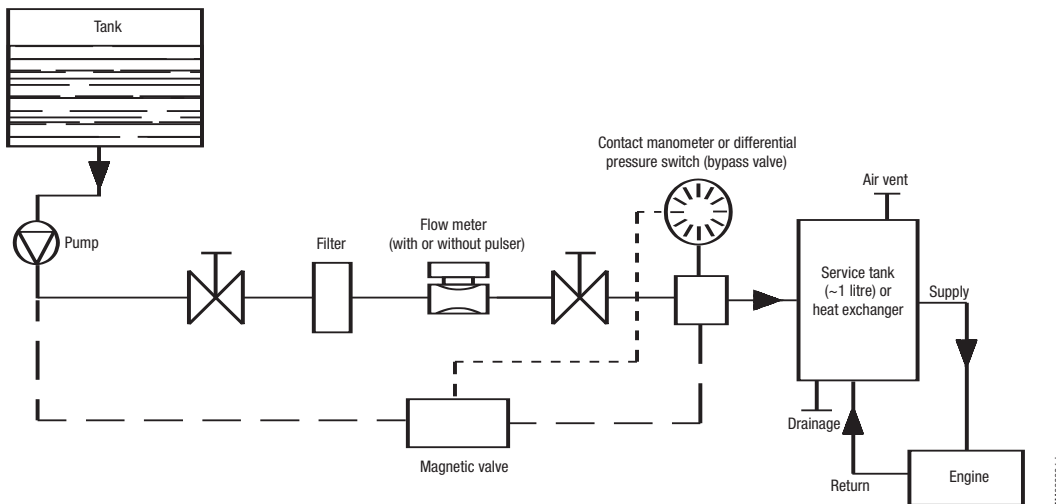

Float or valve control in service tank required. Formation of gas is to be avoided. The magnetic valve opens as soon as the pressure drops below a defined level. For measuring the consumption of more than one engine, each will require a separate installation similar to the one above.

AQUAMETRO AG

Ringstrasse 75
CH-4106 Therwil
Phone 061 725 11 22
Fax 061 725 15 95
info@aquametro.com

AQUAMETRO SA

Rue du Jura 10
CH-1800 Vevey
Phone 021 923 51 30
Fax 021 922 58 44
info@aquametro.com

**AQUAMETRO
MESSTECHNIK GmbH**

Zum Panrepel 24
D-28307 Bremen
Phone 0421 / 871 64-0
Fax 0421 / 871 64-19
info.amd@aquametro.com

**AQUAMETRO
BELGIUM SPRL**

Bd. Lambertmont 131
B-1030 Bruxelles
Phone 02 / 241 62 01
Fax 02 / 216 22 63
info.amb@aquametro.com

AQUAMETRO s.r.o.

Prosecká 811 / 76a
CZ-190 00 Praha 9
Phone 02 / 86 88 77 78
Fax 02 / 86 88 95 59
info.amc@aquametro.com



www.aquametro.com